

Measuring probes
for Class 200 - 300 portable instruments



Wireless communication

instrument/ PC
instrument / probe



Smart-plus system

Wireless or wired probes automatically
recognized when connected to the instrument.

■ Vane Ø 100 mm		Measuring range	Accuracy*	Res.	t ₆₃	Ref.
Air velocity : Hall effect sensor Airflow : calculated Temperature : Pt100 class A. ABS handle (from -40 to +85°C). Detection of rotation direction.	Air velocity	from 0.25 to 3 m/s from 3.1 to 35 m/s	± 3% of reading ± 0,1 m/s ± 1% of reading ± 0.3m/s	0.01 m/s 0.1 m/s	5 sec.	HE 100
	Airflow	from 0 to 99999 m ³ /h	± 3% of reading ± 0.03*area (cm ²)	1 m ³ /h		
	Temperature	from -20 to +80°C	± 0.4% of reading ± 0.3°C	0.1°C		



Secured mini-Din connector.



Retractable cable lg. 450 mm,
up to 2,4 m.

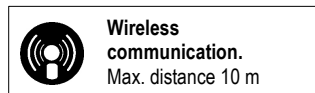
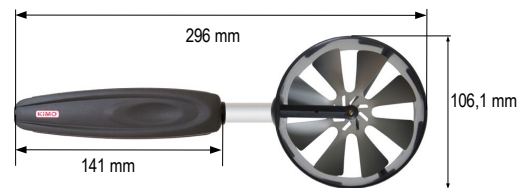

Wireless communication.
Max. distance 10 m



■ Vane Ø 70 mm		Measuring range	Accuracy*	Res.	t ₆₃	Ref.
Air velocity : Hall effect sensor Airflow : calculated Temperature : Pt100 class A. ABS handle (from -40 to +85°C). Detection of rotation direction.	Air velocity	de 0,3 à 3 m/s de 3,1 à 35 m/s	± 3% lecture ± 0.1 m/s ± 1% lecture ± 0.3 m/s	0.1 m/s	5 sec.	HE 70
	Airflow	from 0 to 99999 m ³ /h	± 3% of reading ± 0.03*area (cm ²)	1 m ³ /h		
	Temperature	from -20 to +80°C	± 0.4% of reading ± 0.3°C	0.1°C		

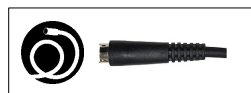

Secured mini-Din connector.





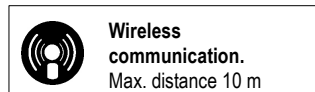
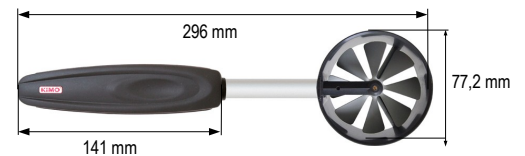



Retractable cable lg. 450 mm,
up to 2,4 m.



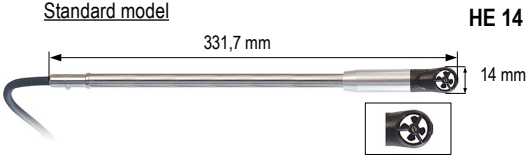
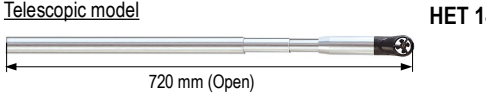

Wireless communication.
Max. distance 10 m

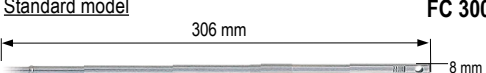

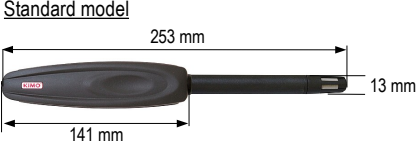
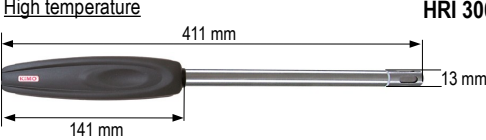

■ Vane Ø 14 mm		Measuring range	Accuracy*	Res.	t ₆₃	Ref.
Air velocity : proximity sensor Airflow : calculated Temperature : Pt100 class A. Straight (HE14) or telescopic (HET14) handle	Air velocity	from 0,8 to 3 m/s from 3,1 to 25 m/s	±3% reading ±0,1m/s ±1% reading ±0,3m/s	0.1 m/s	8 sec.	HE 14 14 mm HET 14 720 mm (Open)
	Airflow	from 0 to 99999 m ³ /h	± 3% of reading ± 0.03*area (cm ²)	1 m ³ /h		
	Temperature	from -20 to +80°C	± 0.4% of reading ± 0.3°C	0.1°C	5 sec. for V _{air} =1m/s	
 Secured mini-Din connector.  Straight cable lg. 1.70mm.		 Standard model 331,7 mm		 Telescopic model 720 mm (Open)		

■ Hotwire		Measuring range	Accuracy*	Res.	t ₆₃	Ref.
Air velocity : NTC regulated in temperature Airflow : calculated Temperature : Pt100 class 1/3 DIN Straight (FC300) or telescopic and gooseneck (FC900) handle	Air velocity	from 0.15 to 3 m/s from 3.1 to 30 m/s	± 3% of reading ± 0.03 m/s ± 3% of reading ± 0.1 m/s	0.01 m/s 0.1 m/s	8 sec.	FC 300 8 mm FCT 900 10 mm
	Airflow	from 0 to 99999 m ³ /h	± 3% of reading ± 0.03*area (cm ²)	1 m ³ /h		
	Temperature	from -20 to +80°C	± 0.3% of reading ± 0.25°C	0.1°C	5 sec. for V _{air} =1m/s	
 Secured mini-Din connector.  Straight cable lg. 1.70mm.		 Standard model 306 mm		 Telescopic and gooseneck model 900 mm (Open)		



■ Hygrometry probe		Measuring range	Accuracy*	Res.	t ₆₃	Ref.
Hygrometry : capacitive sensor Temperature : Pt100 class 1/3 DIN Standard model ABS Sheath and handle (from -40 to +85°C). High temperature model ABS handle (from -40 to +85°C) and inox sheath.	Relative humidity	from 3 to 98%RH	Accuracy** (Repeatability, linearity, hysteresis) : ±1,5%RH (from 15°C to 25°C) Factory calibration uncertainty : ±0,88 %RH Temperature dependence : ±0.04 x (T-20) %RH (if T<15°C or T>25°C)	0.1%RH	<10sec. (from 10%RH to 80%RH; V _{air} =2m/s)	HR 110 13 mm HRI 300 13 mm
	Absolute humidity	Function of humidity and temperature measuring ranges				
	Enthalpy					
	Dew point	from -50 to +80°C _{td}	±0.6% of reading ±0.5°C _{td}	0.1°C _{td}		
	Ambient temperature :					
<i>Standard</i>	from -20 to +80°C	±0.3% of reading ±0.25°C	0.1°C	7sec. V _{air} =1m/s		
<i>High temperature</i>	from -40 to +180°C	±0.3% of reading ±0.25°C	0.1°C	7sec. V _{air} =1m/s		
 Secured mini-Din connector.  Retractable cable lg. 450 mm, up to 2,4 m.		 Standard model 253 mm 141 mm		 High temperature 411 mm 141 mm		

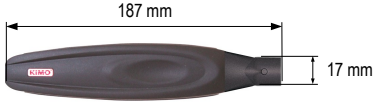

 Wireless communication. Max. distance 10 m	 Standard model HR 110 RF
	 High temperature model HRI 300 RF

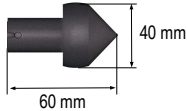

*All accuracies indicated in this document were stated in laboratory conditions and can be guaranteed for measurements carried out in the same conditions, or carried out with required compensation.
**As per NFX 15-113 and the Charter 2000/2001 HYGROMETERS, GAL (Guaranteed Accuracy Limit) which has been calculated with a coverage factor value of 2 is ±2.88%RH between 18 and 28°C on the measuring range from 5 to 95%RH. Sensor drift is less than 1%RH/year.

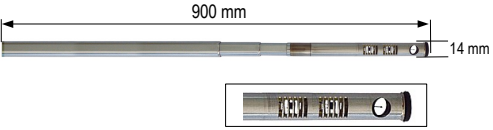
■ Optical tachometry		Measuring range	Accuracy*	Res.	t ₆₃	Ref.
Optical tachometry probe. ABS handle (from -40 to +85°C). (Only for AMI 300)		from 60 to 10000 RPM	± 0.3% of reading ± 1 RPM	1 RPM	2 sec.	TOP
		from 10001 to 60000 RPM	± 30 RPM			
						
	Secured mini-Din connector.	Retractable cable lg. 450 mm, up to 2,4 m.				

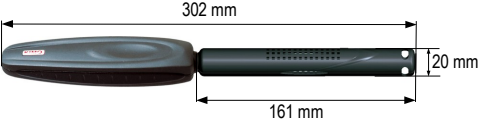

■ Contact adaptor		Measuring range	Accuracy*	Res.	t ₆₃	Ref.
Contact adaptor for optical probe. (Only for AMI 300)		from 30 to 20000 RPM	± 1% of reading ± 1 RPM	1 RPM	2 sec.	ETC
						

■ Multifunction probe		Measuring range	Accuracy*	Res.	t ₆₃	Ref.
Velocity : NTC regulated in temperature Hygrometry : capacif sensor Temperature : Pt100 class 1/3 DIN Telescopic handle (Only for AMI 300)	Velocity	from 0.15 to 3 m/s from 3.1 to 30 m/s	± 3% of reading ± 0.03 m/s ± 3% of reading ± 0.1 m/s	0.01 m/s 0.1 m/s	8 sec.	SVTH
	Relative humidity	from 5 to 95%RH	Accuracy** (Repeatability, linearity, hysteresis) : ±1,8%RH (from 15°C to 25°C) Factory calibration uncertainty : ±0,88 %RH Temperature dependence : ±0.04 x (T-20) %RH (if T<15°C or T>25°C)	0.1%RH		
	Temperature	from -20 to +80°C	± 0.3% of reading ± 0.25°C	0.1°C	5 sec. for V _{air} =1m/s	
						
	Secured mini-Din connector.	Straight cable lg. 1.70mm.				

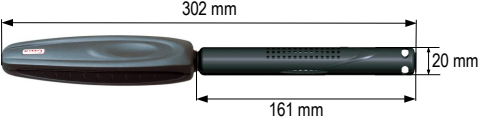
■ CO / temperature probe		Measuring range	Accuracy*	Res.	t ₆₃	Ref.
CO : Electrochemical sensor Temperature : Pt100 class A ABS handle (from -40 to +85°C)	CO	from 0 to 100 ppm from 100 to 1000 ppm	± 5 ppm ± 3% of reading ± 5 ppm	1 ppm	18 sec.	SCOT
	Temperature	from -20 to +80°C	± 0.4% of reading ± 0.3°C	0.1°C		
						
	Secured mini-Din connector.	Retractable cable lg. 450 mm, up to 2,4 m.				

■ CO ₂ / temperature probe		Measuring range	Accuracy*	Res.	t ₆₃	Ref.
CO ₂ : NDIR sensor (Non dispersive- infrared sensor NDIR) Temperature : Pt100 class A ABS handle (from -40 to +85°C)	CO ₂	from 0 to 5000 ppm	± 3% of reading or ± 50 ppm	1 ppm	18 sec.	SC02T
	Temperature	from -20 to +80°C	± 0.4% of reading ± 0.3°C	0.1°C		
						
	Secured mini-Din connector.	Retractable cable lg. 450 mm, up to 2,4 m.				

*All accuracies indicated in this document were stated in laboratory conditions and can be guaranteed for measurements carried out in the same conditions, or carried out with required compensation.
**As per NFX 15-113 and the Charter 2000/2001 HYGROMETERS, GAL (Guaranteed Accuracy Limit) which has been calculated with a coverage factor value of 2 is ±2.88%RH between 18 and 28°C on the measuring range from 5 to 95%RH. Sensor drift is less than 1%RH/year.

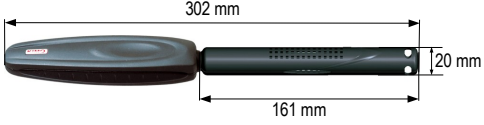
■ CO ₂ / temp./hygro. probe		Measuring range	Accuracy*	Res.	t ₆₃	Ref.
CO ₂ : NDIR sensor (Non dispersive- infrared sensor NDIR)	CO ₂	from 0 to 5000 ppm	±3% of reading or ±50ppm	1 ppm	18 sec.	SCO2TH
Hygrometry : capacitive sensor Temperature : Pt100 class A ABS handle (from -40 to +85°C)	Relative humidity	from 5 to 95%RH	Accuracy** (Repeatability, linearity, hysteresis) : ±1,8%RH (from 15°C to 25°C) Factory calibration uncertainty : ±0,88 %RH Temperature dependence : ±0.04 x (T-20) %RH (if T<15°C or T>25°C)	0.1%RH		
	Temperature	from -20 to +80°C	± 0.4% of reading ± 0.3°C	0.1°C		
 Secured mini-Din connector.		 Retractable cable lg. 450 mm, up to 2,4 m.				

■ Extensions

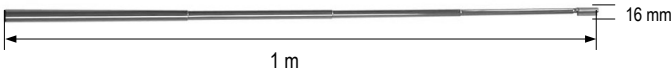
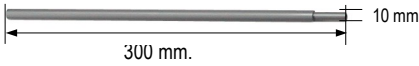
■ General use		Ref.
Telescopic extension compatible with all measuring probes equipped with a handle		RTS
■ For Hotwire		Ref.
Straight extension for hotwire probe		RD 300

*All accuracies indicated in this document were stated in laboratory conditions and can be guaranteed for measurements carried out in the same conditions, or carried out with required compensation.
**As per NFX 15-113 and the Charter 2000/2001 HYGROMETERS, GAL (Guaranteed Accuracy Limit) which has been calculated with a coverage factor value of 2 is ±2.88%RH between 18 and 28°C on the measuring range from 5 to 95%RH. Sensor drift is less than 1%RH/year.

www.kimo.fr

Distributed by :

EXPORT DEPARTMENT

Tel : + 33. 1. 60. 06. 69. 25 - Fax : + 33. 1. 60. 06. 69. 29

e-mail : export@kimo.fr

