

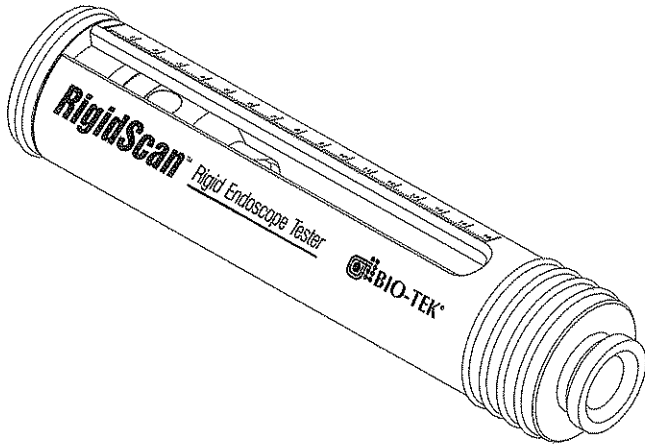

RigidScan™ Rigid Endoscope Tester

Operator's Manual



Bio-Tek® Instruments, Inc.

Part Number 2501000

Revision A

July 2001

Copyright © 2001

Printed in Germany

Notices

BIO-TEK® INSTRUMENTS, INC.

Highland Park, Box 998
Winooski, Vermont, 05404-0998 USA

Customer Service

& Sales: 888.451.5170 (toll free in the U.S.)
Outside USA: 802.655.4040
Sales Fax: 802.655.7941
Service: 800.242.4685 (toll free in the U.S.)
Outside USA: 802.655.4044
Service Fax: 802.655.3399
E-Mail: bmdtac@biotek.com
Internet: <http://www.biotek.com>

International Customer

Service & Product

Support: Contact your local Bio-Tek dealer or service center.

All Rights Reserved

Copyright © 2001, Bio-Tek® Instruments, Incorporated. All rights are reserved. No part of this manual may be reproduced or transmitted in any form, or by any means electronic or mechanical, including photocopying and recording for any purpose other than the purchaser's personal use without written permission of Bio-Tek® Instruments, Inc.

Restrictions and Liabilities

Information in this document is subject to change and does not represent a commitment by Bio-Tek®. Changes made to the information in this document will be incorporated in new editions of the publication. No responsibility is assumed by Bio-Tek® for the use or reliability of software or equipment that is not supplied by Bio-Tek® or its affiliated dealers.

Trademarks

Bio-Tek® is a registered trademark of Bio-Tek Instruments, Inc., and RigidScan™ is a trademark of Bio-Tek Instruments, Inc.

Revision Record

Revision	Date	Change
A	7/01	First Issue

Safety Considerations

Warnings and Cautions

- Do not sterilize the RigidScan.
- Only use the RigidScan with disinfected endoscopes.
- Do not look at the sun or bright lights through the RigidScan, as eye damage could result.



Precautions

The following are provided to help you avoid damaging the RigidScan:

- **Caution: Environmental Conditions.** Do not expose the device to temperature extremes.
- **Caution: Do NOT Immerse.** Clean only with a mild detergent, and gently wipe down with a clean, lint-free cloth.

Warranty

This Warranty is limited and applies only to new products, (except for computer-based software, which is covered under a separate Warranty Policy), manufactured by Bio-Tek Instruments, Inc. ("Bio-Tek"). Bio-Tek makes no warranty whatsoever regarding the condition of used products.

Bio-Tek warrants the instrument (hereinafter collectively referred to as "Products" or "Product") for a period of one (1) year from the original purchase date against defective materials or workmanship. This Warranty is limited to the original purchaser (the "Purchaser") and cannot be assigned or transferred. All claims under this Limited Warranty must be made in writing to Bio-Tek, Attention: Service Department. Purchaser must ship the Product to Bio-Tek, postage pre-paid. Bio-Tek shall either repair or replace with new or like new, at its option and without cost to the Purchaser, any Product which in Bio-Tek's sole judgment is defective by reason of defects in the materials or workmanship.

This Warranty is VOID if the Product has been damaged by accident or misuse, or has been damaged by abuse or negligence in the operation or maintenance of the Product, including without limitation unsafe operation, operation by untrained personnel, and failure to perform routine maintenance. This Warranty is VOID if the Product has been repaired or altered by persons not authorized by Bio-Tek, or if the Product has had the serial number altered, effaced, or removed. This Warranty is VOID if any of the Products has not been connected, installed or adjusted strictly in accordance with written directions furnished by Bio-Tek. Batteries, fuses, light bulbs, and other "consumable" items used in any of the Products are not covered by this Warranty. Software utilized in conjunction with any of the Products is not covered by the terms of this Warranty but may be covered under a separate Bio-Tek software warranty.

We will continue to stock parts for a maximum period of five (5) years after the manufacture of any equipment has been discontinued. Parts shall include all materials, charts, instructions, diagrams, and accessories that were furnished with the standard models.

THIS WARRANTY CONTAINS THE ENTIRE OBLIGATION OF BIO-TEK INSTRUMENTS, INC., AND NO OTHER WARRANTIES, EXPRESSED, IMPLIED, OR STATUTORY ARE GIVEN. PURCHASER AGREES TO ASSUME ALL LIABILITY FOR ANY DAMAGES AND/OR BODILY INJURY OR DEATH THAT MAY RESULT FROM THE USE OR MISUSE OF ANY EQUIPMENT OR INSTRUMENT BY THE PURCHASER, HIS EMPLOYEES, AGENTS, OR CUSTOMERS, OTHER THAN THE EXPRESS WARRANTY CONTAINED HEREIN. WE SHALL NOT BE RESPONSIBLE FOR ANY DIRECT OR CONSEQUENTIAL DAMAGES OF ANY KIND. THIS WARRANTY SHALL NOT BE CHANGED OR MODIFIED IN ANY WAY WITHOUT THE EXPRESS WRITTEN PERMISSION OF AN OFFICER OF BIO-TEK INSTRUMENTS, INC.

THIS WARRANTY IS VOID UNLESS THE PURCHASE REGISTRATION CARD HAS BEEN COMPLETED AND MAILED TO US WITHIN TEN (10) DAYS OF PURCHASE.

Contents

Notices	iii
All Rights Reserved	iii
Restrictions and Liabilities	iii
Trademarks	iii
Revision Record	iv
Safety Considerations	v
Warnings and Cautions	v
Warranty	vi
Chapter 1: Introduction and Description.....	1-1
Introduction to the RigidScan.....	1-1
Package Contents	1-1
System Characteristics.....	1-2
System Illustration	1-2
Figure 1-1. RigidScan Component Illustration.....	1-3
Chapter 2: Theory of Operation.....	2-1
Construction of Rigid Endoscopes.....	2-1
Figure 2-1. Jacket Tube of Rigid Endoscope (10-mm Laparoscope).....	2-1
Figure 2-2. Inner Tube of Rigid Endoscope.....	2-1
Figure 2-3. Rod Lenses and Distance Pieces of Innermost Rigid Endoscope Tube	2-2
Figure 2-4. Common Tip Angles for Rigid Endoscopes	2-2
Frequently Used Endoscopy Terminology.....	2-3
Figure 2-5. Laparoscope	2-3
Figure 2-6. Arthroscope.....	2-3
Figure 2-7. Cystoscope	2-3
Endoscope Damage	2-4

Chapter 3: Using the RigidScan	3-1
Preparing to Use the RigidScan	3-1
Figure 3-1. RigidScan with an Endoscope	3-2
Checking for Broken Rod Lenses	3-3
Figure 3-2. Broken Lens	3-3
Figure 3-3. The RigidScan "Scale"	3-3
Checking for Lens Debris	3-4
Figure 3-4. Dusty Lens	3-4
Checking for Problems with the Glue	3-5
Figure 3-5. Decreased Transmission Caused by Glue Degradation Inside the Lens	3-5
Performing the Shaft Straightness Test	3-6
Figure 3-6. RigidScan Shaft Straightness Test	3-6
Evaluating the Visible Image by Focusing on a Reference Object	3-6
Figure 3-7. Reference Object	3-7
Capturing Images for Later Reference	3-7

Chapter 4: Maintenance and Support	4-1
Cleaning the RigidScan	4-1
Service	4-2
Parts List	4-3

Appendix A: Specifications	A-1
---	------------

Introduction and Description

Chapter

1

1. Introduction to the RigidScan
2. Package Contents
3. System Characteristics
4. System Illustration

1. Introduction to the RigidScan

The Bio-Tek RigidScan is a highly versatile, easy-to-use instrument that is used to identify damage to the optical system of most rigid endoscopes constructed with rod lenses. Specifically, the RigidScan consists of a holding tube and a magnified lens, making it possible to hold and manipulate rigid endoscopes while checking for cracked lenses, foreign bodies, and dust on the lens surfaces.

The instrument has been designed for use by biomedical engineers, field service engineers, and third-party repair organizations as a portable troubleshooting instrument to diagnose fractures, mechanical damage, and dirt particles that may impair the quality of the viewed image of an endoscope. The RigidScan can also be used in hospitals as a tool to check the endoscopes for mechanical damage after use in the operating room and as the last step before they are sterilized.

2. Package Contents

The following accessories are shipped standard with the RigidScan. To order additional quantities, contact your Bio-Tek equipment dealer, and use the Bio-Tek Part Numbers provided:

Description	Qty. Supplied	Part No.
Operator's Manual	1	2501000
Warranty Card	1	94001

3. System Characteristics

The RigidScan is simple to use. By removing the end cap and inserting a rigid endoscope, the viewer has the ability to detect broken or damaged rod lenses.

Some of the key features of the RigidScan include:

- Small and lightweight
- Quick determination of broken rod lenses
- Quick determination of damaged rod lenses
- Holds rigid endoscopes of most common sizes
 - ⇒ 10 mm diameter (e.g., laparoscope)
 - ⇒ 4 mm diameter (e.g., arthroscope)
 - ⇒ or smaller diameter
- Includes instructions on overlay
- Compatible with common endoscopic cameras for hard-copy documentation and meets the DIN 58105 Standard
- Includes incremental markings along the Guide Tube for repeatable testing
- Portable - All parts can be stored in the Guide Tube

Hospitals may find it possible to save money by using the RigidScan to confirm damaged endoscopes so that only damaged endoscopes are sent out for repair.

Manufacturers and repair organizations may find that the RigidScan reduces the amount of time debating with a customer about claims.

The RigidScan offers a means to determine obvious damage to some of the lenses of rigid endoscopes.

4. System Illustration

Figure 1-1 illustrates the system, with all components identified.

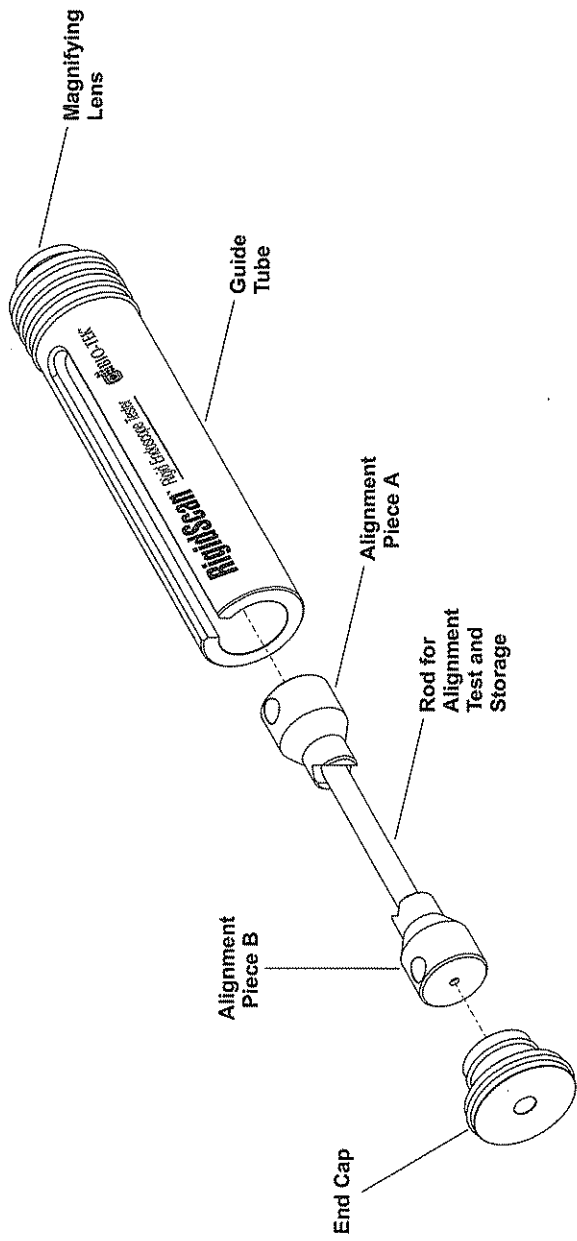

Figure 1-1. RigidScan Component Illustration

Theory of Operation

Chapter

2

1. Construction of Rigid Endoscopes
2. Frequently Used Endoscopy Terminology
3. Endoscope Damage

1. Construction of Rigid Endoscopes

A rigid endoscope consists of three basic components through which light is passed into the body and an image is passed out of the body. The outermost component is a jacket tube, which contains the light or cable connector and outer eyepiece (*Figure 2-1*). The jacket tube is sealed, thus preventing foreign materials and humidity from reaching the inner components.



Figure 2-1. Jacket tube of rigid endoscope (10-mm laparoscope)

Inside is an inner tube (*Figure 2-2*) that has an eyepiece at the proximal end and a deflector prism at the distal end.

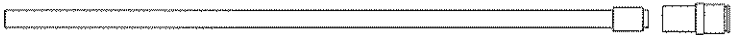

Figure 2-2. Inner tube of rigid endoscope

The innermost component of the endoscope, shown in *Figure 2-3*, consists of the optical rod lenses (Gradient Index lenses, or GRIN lenses) and distance pieces. The optical system of a rigid endoscope is composed of numerous optical elements. Some are used to capture the reflected light within the body, some transmit light and image, while others magnify and focus the image at the eyepiece.

Rod lenses are commonly made from different kinds of glass that are glued together.

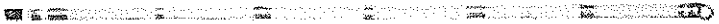

Figure 2-3. Rod lenses and distance pieces of innermost rigid endoscope tube

The distal ends of rigid endoscopes typically have tips of 0, 30 or 45 degrees as shown in *Figure 2-4*.

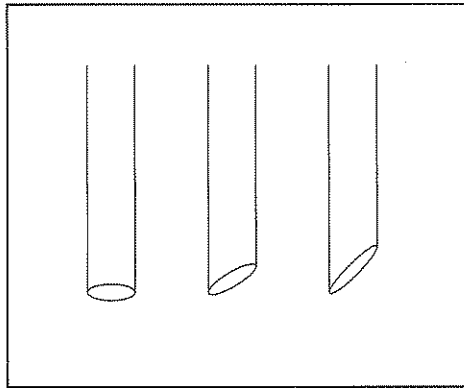

Figure 2-4. Common tip angles for rigid endoscopes

2. Frequently Used Endoscopy Terminology

Laparoscope – Used in laparoscopic procedures such as gall bladder surgery (shown with a 30-degree angle tip).

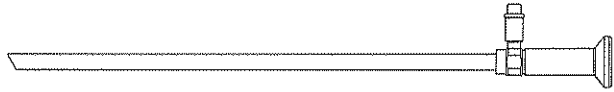

Figure 2-5. Laparoscope

Arthroscope – Used for minimally invasive surgeries of the musculoskeletal system, such as knee surgery.

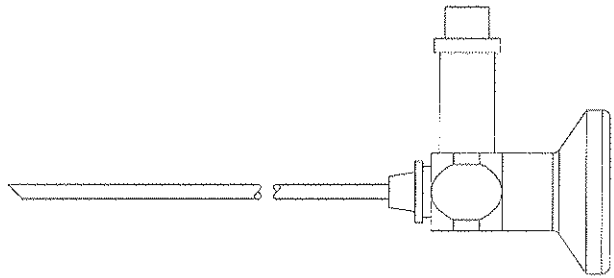

Figure 2-6. Arthroscope

Cystoscope – Used for examining the urinary tract.

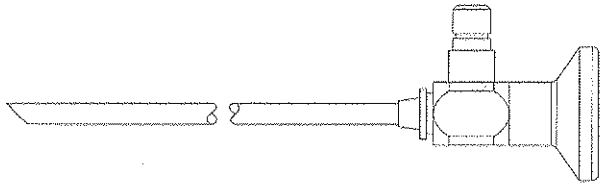

Figure 2-7. Cystoscope

3. Endoscope Damage

Understanding the construction of endoscopes helps one realize how fragile they are and how easily they can be damaged.

Any stress-induced bend of the rod may cause internal compression and external stretching. Although the endoscope may still be usable, the optical quality is greatly reduced.

If an endoscope is dropped or mishandled, the lenses are likely to crack, thus impacting the optical quality.

Other damage can be caused by an improperly assembled endoscope (e.g., glue remnants), or dirt and dust particles inside the endoscope. Broken seals may allow moisture to enter the endoscope, thus temporarily clouding the image.

Using the RigidScan

Chapter

3

1. Preparing to Use the RigidScan
2. Checking for Broken Rod Lenses
3. Checking for Lens Debris
4. Checking for Problems with the Glue
5. Performing the Shaft Straightness Test
6. Evaluating the Visible Image by Focusing on a Reference Object
7. Capturing Images for Later Reference

1. Preparing to Use the RigidScan



Warning! Only use with disinfected endoscopes.

1. Remove the End Cap and extract the Alignment Rod and End Pieces (refer to *Figure 1-1*).
2. Insert the endoscope into the Guide Tube, and align the eyepiece end of the endoscope with the eyepiece of the RigidScan (*Figure 3-1*). Guide the distal end of the endoscope through the alignment holder of the appropriate size, and then slide it inside the Guide Tube. You can then insert the End Cap, which will hold the endoscope in place.
3. Point the distal end of the endoscope toward a bright illuminated area (such as a white piece of paper) and look through the RigidScan eyepiece while slowly moving the endoscope along the Guide Tube. Do this by grasping the light adapter of the endoscope and sliding it.



Warning! Do not look at the sun or bright lights through the RigidScan, as eye damage could result.

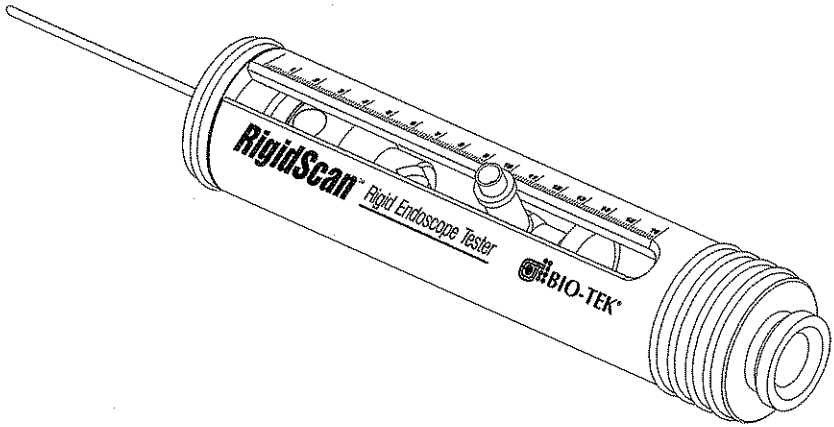

Figure 3-1. RigidScan with an endoscope

2. Checking for Broken Rod Lenses

Broken rod lenses can be determined by inspecting the rod lens surfaces.

1. While the endoscope is inside the RigidScan and the viewer is sliding it slowly back and forth, if any cracks are observed the endoscope is damaged. The damage seen when viewing the endoscope with the RigidScan is most likely not visible without using the RigidScan. An image of a broken lens is shown in *Figure 3-2*.

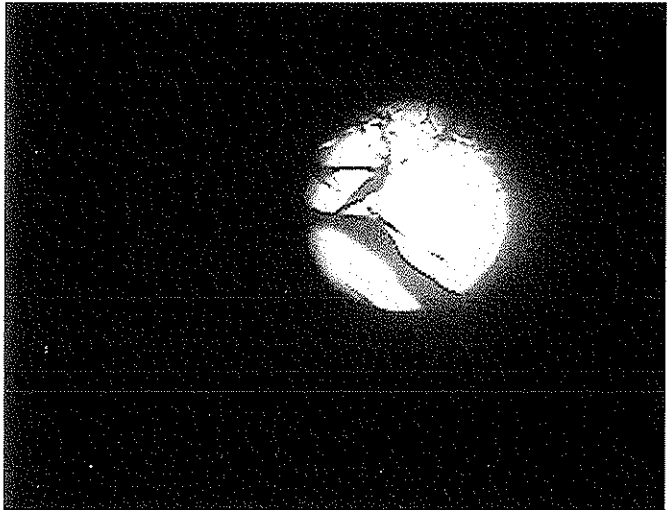

Figure 3-2. Broken lens

2. The numbered scale on the overlay (*Figure 3-3*) can be referenced to make it easier to find the suspect spot when repeating the test.



Figure 3-3. The RigidScan "scale"

3. Checking for Lens Debris

Dirt, metal fragments that may appear as hairs, dust particles or other contaminants may appear as spots on the lens, thereby not giving the physician a clear image. By viewing the endoscope with the RigidScan, these contaminants become more distinguishable.

The quality of the images relayed by endoscopes deteriorates over time. Instead of seeing brilliant, clear, precise images, the images are dull and milky.

Normal wear and tear of the temperature-related movement between the metal shaft and the glass lenses can create dust, which attaches itself to the surfaces of the lens. An example of a dusty lens is shown in *Figure 3-4*.

There is no transmission of light where the dust particles are present, and this reduces the sharpness of the image. Although some dust particles are normal, even in new endoscopes, the image in *Figure 3-4* indicates a repair is needed.

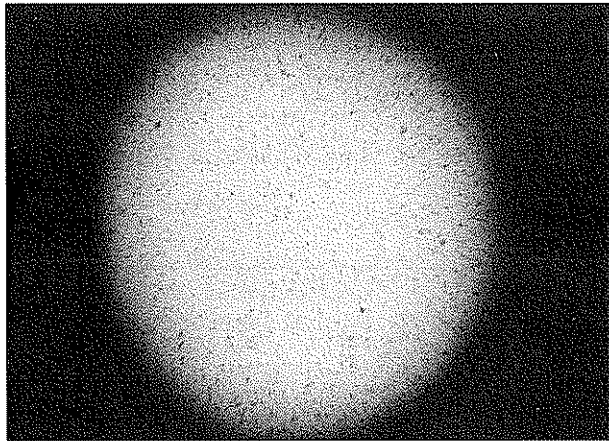

Figure 3-4. Dusty lens

4. Checking for Problems with the Glue

Glue is used to bond the different types of glass that comprise a lens. The glue can change its color and lose its adhesiveness after repeated sterilizations and general wear and tear. This results in a decrease in the transmission, which may be visible by using the RigidScan as shown in *Figure 3-5*.

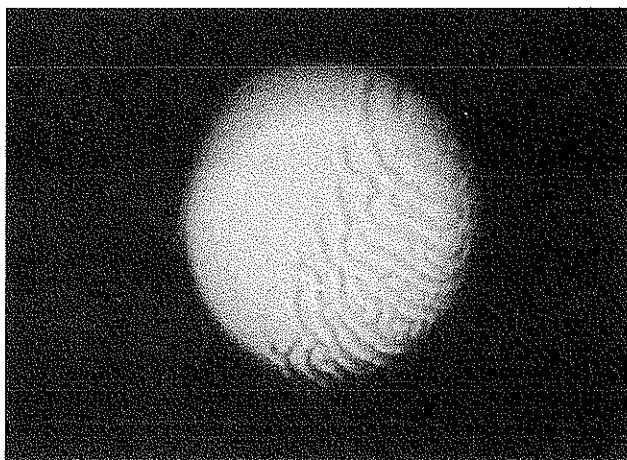

Figure 3-5. Decreased transmission caused by glue degradation inside the lens

Note: Contact your endoscope manufacturer when you have concerns about an endoscope. The manufacturer is the most knowledgeable resource.

5. Performing the Shaft Straightness Test

To perform the Shaft Straightness Test (*Figure 3-6*), slide the Alignment Rod into the alignment end pieces and place the endoscope in the depression. Holding the distal end of the endoscope with one hand, gently use your finger to slowly rotate the endoscope. If the rolling motion of the endoscope is not smooth and even, the optical axis of the endoscope is not straight, which may be caused by a damaged rod lens.

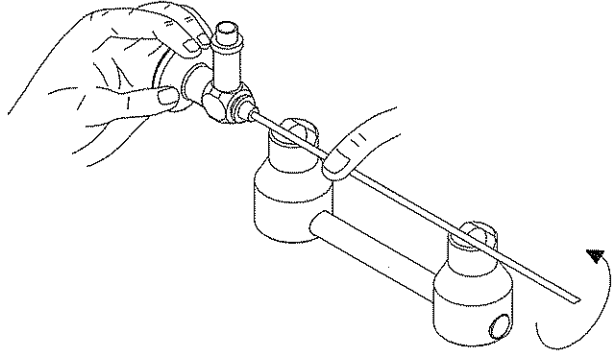

Figure 3-6. RigidScan Shaft Straightness Test

Note: The distance between the alignment parts can be changed, and may differ from that shown.

6. Evaluating the Visible Image by Focusing on a Reference Object

Focusing on a reference object gives the viewer the opportunity to make judgment calls on the quality of the image (*Figure 3-7*). A reference object can be a target developed specifically for optical viewing, or it can be anything with color and detail that could be used to determine sharp edges and distinct color.

Remove the endoscope from the RigidScan. In a well-illuminated area, direct the endoscope to a reference object and determine if the brightness and sharpness of the reference object is acceptable.

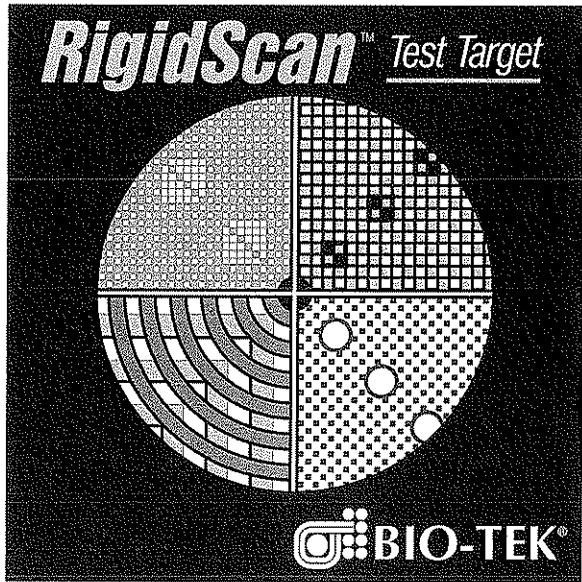

Figure 3-7. Reference object

7. Capturing Images for Later Reference

The eyepiece of the RigidScan is compatible with the standard eyepiece of video cameras, thereby making it possible to capture images from the optical system of rigid endoscopes. Since most hospitals have the equipment in place (video camera, printer, light source), it is possible to capture images for later reference.

1000
900
800
700
600
500
400
300
200
100
0



Maintenance and Support

Chapter

4

1. **Cleaning the RigidScan**
2. **Service**
3. **Parts List**

Your RigidScan needs little maintenance or special care. There is no scheduled maintenance for the RigidScan, as the device does not require calibration. Avoid dropping the instrument or other mechanical abuse that could cause damage to the lenses.

1. **Cleaning the RigidScan**

Clean the instrument occasionally with a damp cloth and a mild detergent. Take care to avoid the entrance of liquids.



Caution: Do not immerse the RigidScan in liquid.

Note: The RigidScan does not require any calibration.

2. Service

If your new RigidScan fails to operate successfully, please contact Bio-Tek's Technical Assistance Center immediately.

International customers should contact their Bio-Tek dealer for service/product support. To obtain the name of your local dealer or service center, call, send a fax, access Bio-Tek on the Internet, or send an e-mail message:

Phone: 802.655.4044 (800.242.4685,
toll free in the U.S.)
Fax: 802.655.3399
Internet: <http://www.biotek.com>
E-mail: bmdtac@biotek.com

If repairs are required, return the RigidScan to the factory or Service Center, packed in the original shipping container, using packing materials supplied by Bio-Tek.

Before returning the RigidScan for factory service, contact Bio-Tek's Technical Assistance Center for a required **Return Authorization Number**.

Whichever method of contact you choose, please provide the following information:

- The RigidScan serial number
- The specific steps that reproduce your problem
- A daytime phone number
- Your name/company
- A fax number (if available)

1. Pack the instrument carefully, using the original packing materials. If the original packing materials are not available, contact Bio-Tek for replacement packing. **Failure to pack the instrument properly could void your warranty.**

Place the **Return Authorization Number** in a prominent place on the outside of the packing box, and refer to the number in any correspondence with Bio-Tek Service.

2. Enclose your return address and **Return Authorization Number**.
3. Insure the unit for full retail value and ship to:

Bio-Tek Instruments, Inc.
Service Department
Highland Park
Winooski, VT 05404-0998 USA

3. Parts List

The following parts can be ordered should they be misplaced or damaged:

Bio-Tek Part No.	Description
48554	Alignment Piece A (4 mm)
48553	Alignment Piece B (10 mm)
48552	Rod for Alignment and Storage
2501001	Overlay
2501000	Manual

Specifications

Appendix

A

1. Environmental Conditions
2. Outer Diameter of Eyepiece
3. End Cap Diameter
4. Optical Design

1. Environmental Conditions

Operating Temperature	15 to 40°C
Storage Temperature	-20 to +65°C
Relative Humidity	90% max

2. Outer Diameter of Eyepiece

The outer diameter of the magnifying lens eyepiece is 31.75 mm + 0 - 0.1 per DIN 58105. This makes it possible to adapt a video/camera eyepiece to the RigidScan eyepiece.

3. End Cap Diameter

The diameter of the endcap and shaft is 10 mm. This makes it possible to accommodate rigid endoscopes that are < 10 mm in diameter.

4. Optical Design

Design	Bi-Convex Lens
Focal Length	40 mm ± 3%
Refraction	25 dpt
Material	PMMA (Plexiglas)
Diameter	19 mm

For more information, please contact your Bio-Tek Service representative.

