



*Quality and reliability is our tradition*

# KYORITSU

**Blue Panther**  
instruments



**Test and Measuring Instruments  
General Catalogue 2023-2024**

*Japan*  
QUALITY

# KYORITSU NEW PRODUCTS



## KEW 4506 INTELLIGENT SOCKET TESTER

- Perfect socket tester that finds out the difficult-to-detect N-E Reverse connection
- Easy measurement by simply plugging into a socket outlet and pressing the test button
- KEW 4506 can be used on TT earth system and combined with KEW 8343, also on TN-S (See measurement principle)

P.73

Applicable to the socket outlet types of each country

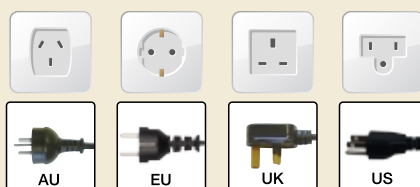

Standard Type



## KEW 8343 SIGNAL SOURCE FOR INTELLIGENT SOCKET TESTER

## KEW 8031 Phase Indicators

- Long selling models were renewed with the design and the measurement category
- Check of open phase and phase sequence are possible in one unit
- Measuring range for 3-phase installations from 110V to 600V

P.77



CE Type

# CONTENTS

## SYMBOLS

	TRUE RMS
	CAT IV 600V
	DC/AC V
	DC/AC A
	DC Voltage
	AC Voltage
	DC Current (A)
	AC Current (A)
	DC+AC measurement
	Power
	MAX MIN AVG
	MAX MIN
	Resistance
	Continuity buzzer
	Diode
	Capacitance
	Temperature
	Frequency
	Power factor
	Harmonics
	Phase rotation
	Decibel
	Duty cycle ratio
	Non Contact Voltage
	Back light
	Water proof
	Peak hold
	Data hold
	Auto power off
	Auto power save
	Output
	Filter
	Relative
	External Power Supply
	USB
	Low power Ω
	Bluetooth®

## MULTIMETERS

1009, 1011/1012, 1019R, 1020R/1021R, 1030, 1051/1052, 1061/1062, 1109S, 1110, 2000A/2001A/2012RA

P.9 - P.16

## CLAMP METERS

2002PA/2002R, 2003A, 2007R, 2009R, 2010, 2031, 2033, 2046R, 2055/2056R, 2117R, 2127R, 2200/2200R, 2204R, 2210R, 2300R, 2413F/2413R, 2431, 2432, 2433/2433R, 2434, 2500/2510, 8112, 8115, 8161

P.17 - P.29

## INSULATION TESTERS

3005A, 3007A, 3021A/3022A/3023A, 3025A/3125A, 3121B/3122B, 3123A, 3124A, 3127, 3128, 3131A, 3132A, 3161A, 3165/3166, 3431, 3551/3552/3552BT

P.30 - P.41

## EARTH TESTERS

4102A, 4105A, 4105DL, 4106, 4200/4202, 4300

P.42 - P.47

## LOOP/PSC/RCD TESTERS

4118A, 4140, 5406A, 5410

P.48 - P.50

## PORTABLE APPLIANCE TESTERS

6205

P.51 - P.52

## MULTI FUNCTION TESTERS

6010B, 6011A, 6018, 6024PV, 6516/6516BT

P.53 - P.59

## POWER METERS

2060BT, 2062/2062BT, 6305, 6315

P.60 - P.65

## LOGGERS

5010/5020, 5050

P.66 - P.69

## SENSORS

8121, 8122, 8123, 8124, 8125, 8126, 8127, 8128, 8130, 8133, 8135, 8146, 8147, 8148, 8177, 8178, 8309

P.70 - P.72

## INTELLIGENT SOCKET TESTERS

4506, 8343

P.73 - P.75

## OTHERS

5202, 5204/5204BT, 5515, 5711, 8031/8031F, 8035

P.76 - P.77

## KEWTECH

KT170/171, KT200, KT203

P.78 - P.79

## ACCESSORIES

Test Leads

P.80 - P.85

## GLOSSARY/PRODUCT INDEX/QUALITY CONTROL CONCEPT

P.86 - P.91



## Safety Warnings

Please read the "Safety Warnings" in the instruction manual supplied with the instrument thoroughly and completely for safety use. Failure to follow the safety rules can cause fire, trouble, electrical shock, etc. Therefore, make sure to operate the instrument on a correct power supply and voltage rating marked on each instrument.

Blue Panther s.r.o. Mezi Vodami 29, 143 00, Praha, Česká republika. Tel.: 241762724, Fax: 241773251

[www.blue-panther.cz](http://www.blue-panther.cz), [www.blue-panther.sk](http://www.blue-panther.sk)

MULTIMETERS

CLAMP METERS

INSULATION TESTERS

EARTH TESTERS

LOOP/PSC/RCD TESTERS

PORTABLE APPLIANCE TESTERS

MULTI FUNCTION TESTERS

POWER METERS

LOGGERS

SENSORS

INTELLIGENT SOCKET TESTERS

OTHERS

KEWTECH

ACCESSORIES

GLOSSARY/PRODUCT INDEX/QUALITY CONTROL CONCEPT

# KYORITSU LINE UP

## ANALOGUE MULTIMETERS

## DIGITAL MULTIMETERS

KEW <b>1109S</b> P12  CE	MODEL <b>1110</b> P12  CE	MODEL <b>1009</b> P12  CE	KEW <b>1011</b> P12  CE	KEW <b>1012</b> P12  CE TRUE RMS	KEW <b>1019R</b> P13  CE TRUE RMS	KEW <b>1020R</b> P11  CE TRUE RMS	KEW <b>1021R</b> P11  CE TRUE RMS
--	---	---	---	---	---	--	--

## DIGITAL CLAMP METERS

MODEL <b>2002PA</b> MODEL <b>2002R</b> P20  CE 2002R TRUE RMS Φ55 MAX AC2000A	KEW <b>2007R</b> P20  CE TRUE RMS Φ33 MAX AC1000A	MODEL <b>2031</b> P20  CE Φ24 MAX AC 200A	KEW <b>2117R</b> P21  CE TRUE RMS Φ33 MAX AC1000A	KEW <b>2127R</b> P21  CE TRUE RMS Φ33 MAX AC1000A	KEW <b>2200/2200R</b> P21  CE 2200R TRUE RMS Φ33 MAX AC1000A	KEW <b>2204R</b> P22  CE TRUE RMS Φ70 MAX AC 400A
--	--	---	--	---	--	--

## DIGITAL CLAMP METERS

## LEAKAGE CLAMP METERS

KEW <b>2500/2510</b> P25  CE Φ6	MODEL <b>2300R</b> P27  CE TRUE RMS Φ10 MAX AC/DC 100A	KEW <b>2413F/2413R</b> P27  CE 2413R TRUE RMS Φ68 MAX AC1000A	MODEL <b>2431</b> P26  CE Φ24 MAX AC 200A	MODEL <b>2432</b> P26  CE Φ40 MAX AC 100A	MODEL <b>2433/2433R</b> P26  CE 2433R TRUE RMS Φ40 MAX AC 400A	MODEL <b>2434</b> P27  CE Φ28 MAX AC 100A
---	--	--	--	---	---	--

## ANALOGUE INSULATION TESTERS

## HIGH VOLTAGE INSULATION TESTERS

MODEL <b>3161A</b> P35  CE 3161A(15V/500V)	MODEL <b>3165/3166</b> P35  3165(500V) 3166(1000V)	KEW <b>3431</b> P35  CE 3431(250V/500V/1000V)	KEW <b>3121B/3122B</b> P37  CE 3121B(2500V) 3122B(5000V)	KEW <b>3123A</b> P38  3123A(5000/10000V)	KEW <b>3124A</b> P38  3124A(1k -10kV Variable)
--	---	--	---	--	--

## EARTH CLAMP TESTERS

## EARTH TESTERS

## LOOP/PSC TESTERS

## RCD TESTERS

## PORTABLE APPLIANCE TESTER

MODEL <b>4200</b> KEW <b>4202</b> P47  CE TRUE RMS	KEW <b>4300</b> P46  CE TRUE RMS	MODEL <b>4118A</b> P48  CE	KEW <b>4140</b> P49  CE	MODEL <b>5406A</b> P50  CE	KEW <b>5410</b> P50  CE	KEW <b>6205</b> P52  CE
--	---	--	---	---	---	---

## POWER METERS

## LOGGERS

## INTELLIGENT SOCKET TESTERS

## OTHERS

KEW <b>6305</b> P62  CE TRUE RMS	KEW <b>6315</b> P64  CE TRUE RMS	KEW <b>5010/5020</b> P66  CE TRUE RMS	KEW <b>5050</b> P68  CE TRUE RMS	KEW <b>4506</b> P74  CE NEW	KEW <b>8343</b> P74  CE NEW	MODEL <b>5202</b> P76  CE
---	---	--	---	--	--	---



## DIGITAL MULTIMETERS



## DIGITAL CLAMP METERS



## DIGITAL INSULATION/CONTINUITY TESTERS

## ANALOGUE INSULATION/CONTINUITY TESTERS



## HIGH VOLTAGE INSULATION TESTERS

## EARTH TESTERS

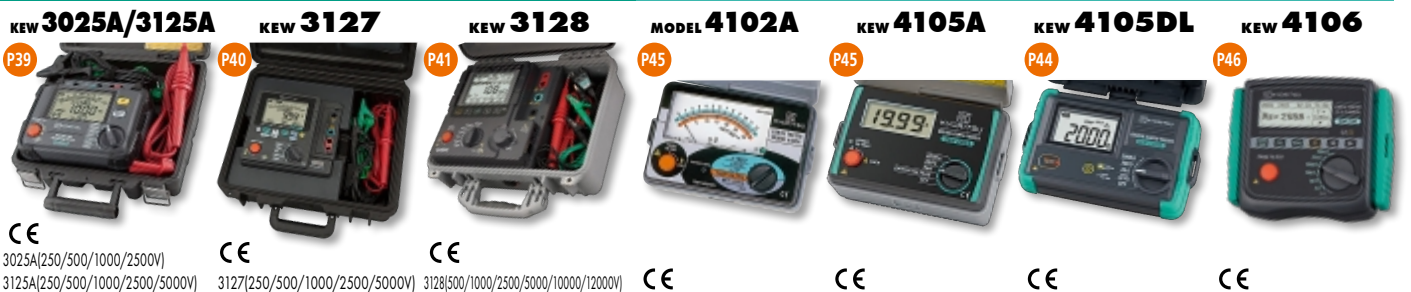

## MULTI FUNCTION TESTERS

## POWER METERS



## OTHERS

## KEWTECH



## INDUSTRIAL

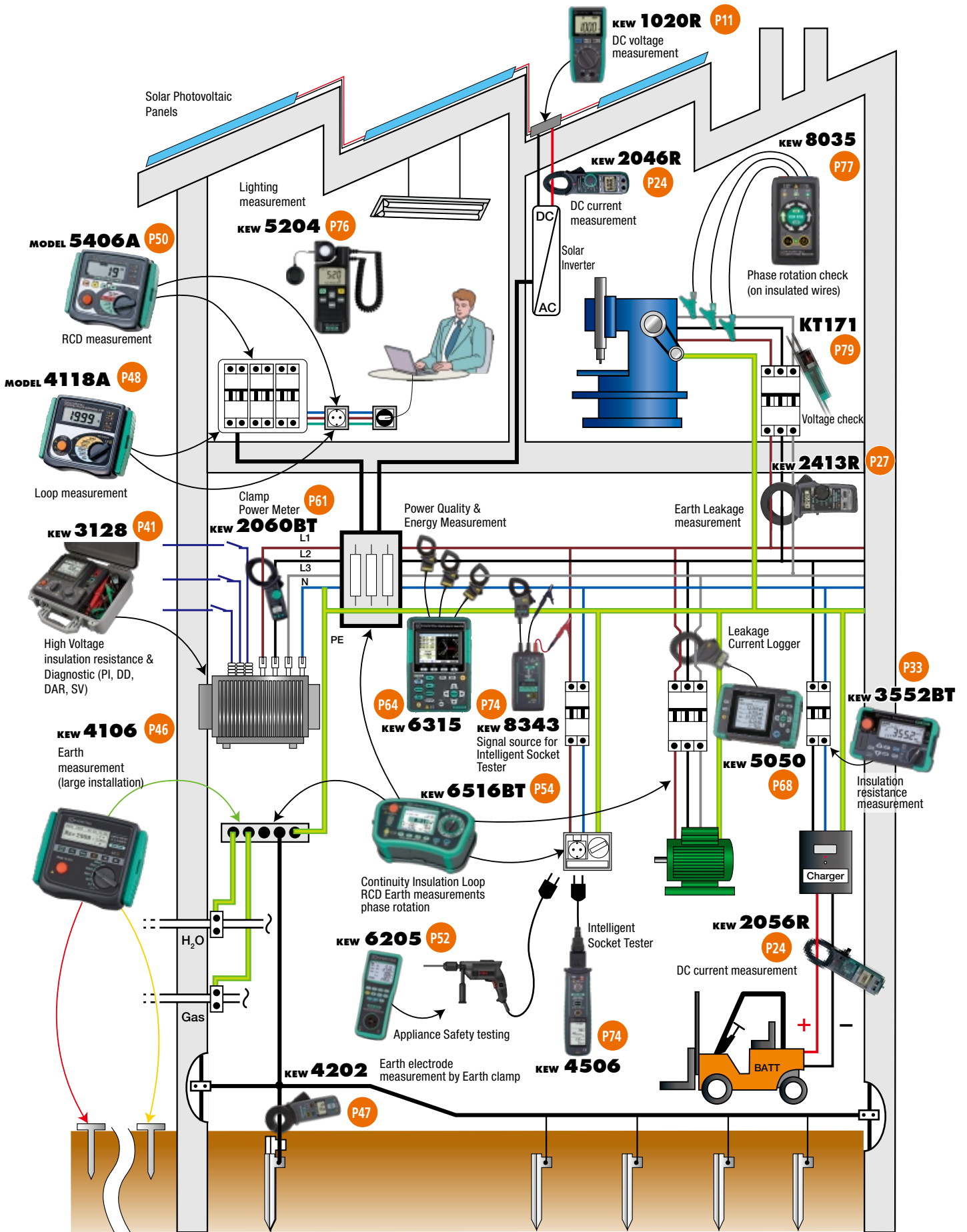

# RESIDENTIAL

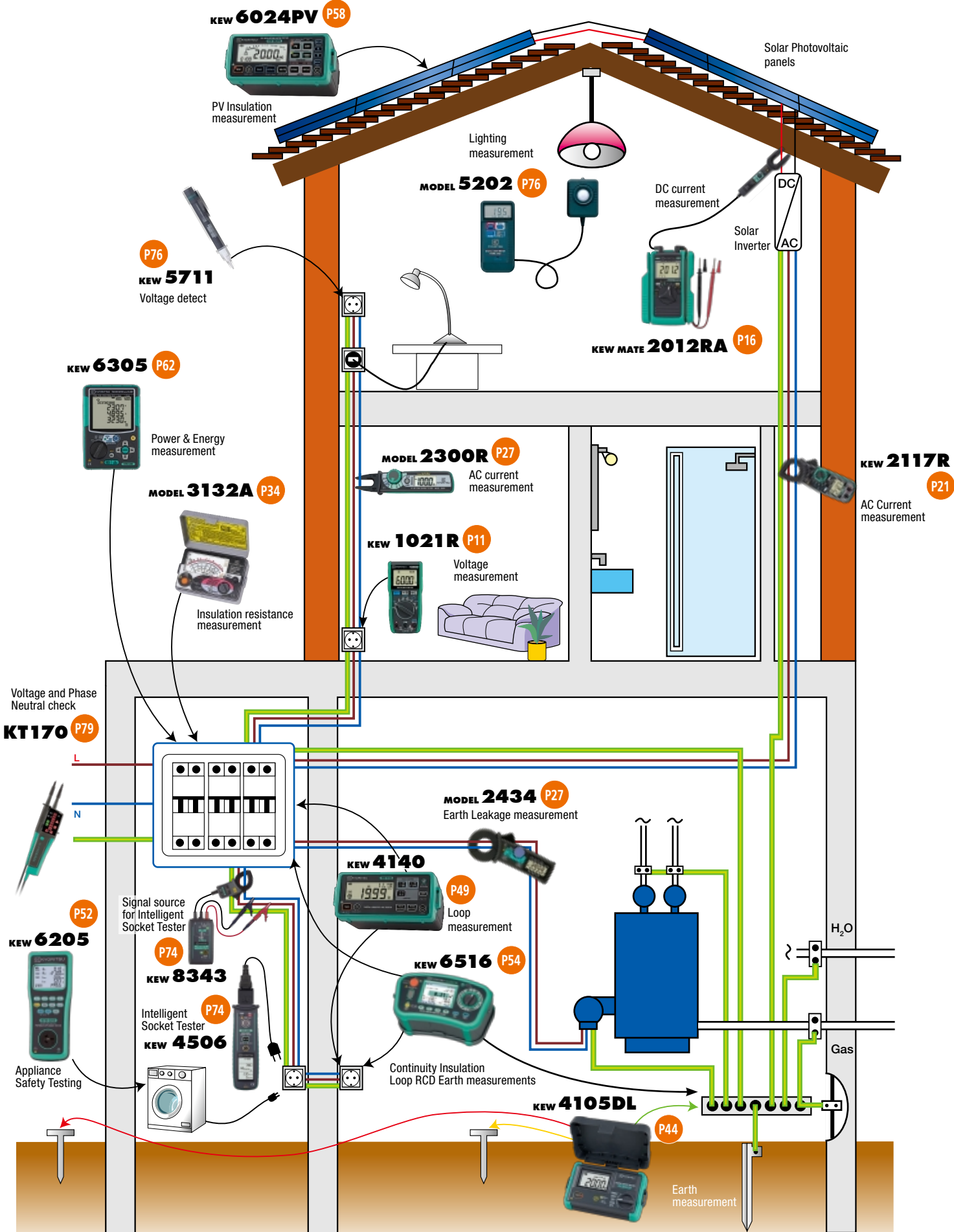

# Special measurement application "KEW CONNECT"

## Maintenance work till now...



Takes time due to many measurement points



Manual input is hard and error-prone

Spend a lot of time writing reports



Input work is troublesome



## From now...

Auto data save



E-mail the data at the site



Just copy and paste the mailed data to create reports.

Easy!  
Data transfer

Quick!  
Report creation

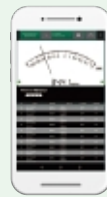

- No miss-transcription
- Reducing labor cost
- Eliminating data input work



## FREE App "KEW CONNECT" supporting iOS/ Android devices



**KEW Smart Advanced**

KEW 3552BT / KEW 6516BT / KEW 5204BT



**KEW Power\***

KEW 2060BT / KEW 2062BT



Android™ App

Download from Google Play Store for FREE.  
Supporting Android Ver. 5.0 or later.



iOS App

Download from App Store for FREE.  
Supporting iPhone, iPad, and iPod touch with iOS 10.0 or later.

\* Please note that communication charge is incurred separately for downloading the applications.

\* Bluetooth® is the trademark or registered trademark of Bluetooth SIG.

\* Android™ is the trademark or registered trademark of Google Inc.

\* iOS is the trademark or registered trademark of Cisco in the U.S. and other countries and is used under license.

## Models supported by KEW CONNECT:

**KEW 2060BT**  
CLAMP POWER METER

**KEW 2062BT**  
CLAMP POWER METER

**KEW 3552BT**  
DIGITAL INSULATION/CONTINUITY TESTER

**KEW 5204BT**  
DIGITAL LIGHT METER

**KEW 6516BT**  
MULTI FUNCTION TESTER





# MULTIMETERS

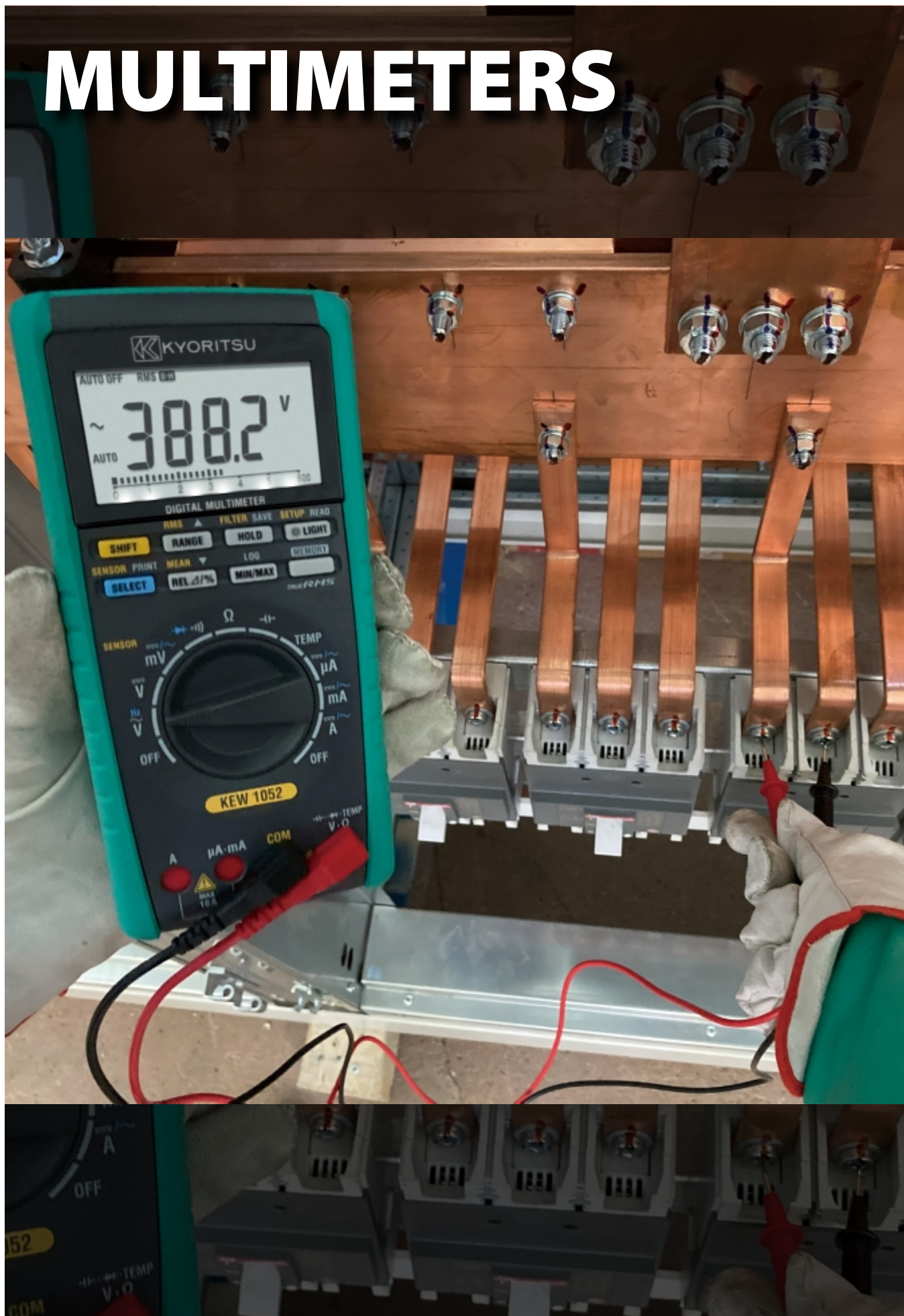

# MULTIMETERS

Selection Guide of Multimeters

		Analogue Multimeters		Digital Multimeters									
		1109S	1110	1019R	1020R	1021R	1030	1009	1011 1012	1051 1052	1061 1062	2000A 2001A	2012RA
Appearance													
Detection method		-	-	✓	✓	✓	-	-	✓ (1012)	✓	✓	-	✓
Maximum count display		-	-	6000	6000	6000	4000	3999	6000	6000	50000	3400	6000
DC Basic accuracy		±3% of FS	±3% of FS	0.8%	0.5%	0.5%	0.8%	0.6%	0.5%	0.09%	0.02%	1.5%	1.0%
Frequency response		30 - 20kHz	50 - 5kHz	45 - 500Hz	40 - 500Hz	40 - 500Hz	50 - 400Hz	50 - 400Hz	40 - 1kHz	40 - 1kHz	10 - 20kHz(1061) 10 - 100kHz(1062)	50 - 400Hz	45 - 400Hz
<b>Measurement</b>													
DC V	Max	1000V	600V	600V	1000V	600V	600V	600V	600V	1000V	1000V	600V	600V
	Resolution	0.002V	0.005V	0.1mV	0.1mV	0.1mV	0.1mV	0.1mV	0.1mV	0.1mV	0.001mV	0.1mV	0.1mV
AC V	Max	1000V	600V	600V	1000V	600V	600V	600V	600V	1000V	1000V	600V	600V
	Resolution	0.2V	0.2V	0.001V	0.1mV	0.1mV	0.001V	0.1mV	0.001V	0.1mV	0.01mV(1061) 0.001mV(1062)	0.001V	0.001V
DCA	DC A	250mA	300mA	-	-	10A	-	10A	10A	10A	10A	60A(2000A) 100A(2001A)	120A
ACA	AC A	-	-	-	-	10A	-	10A	10A	10A	10A	60A(2000A) 100A(2001A)	120A
DC+AC	DC+AC	-	-	-	-	-	-	-	-	-	✓	-	-
Resistance	Ω	20MΩ	300KΩ	40MΩ	40MΩ	40MΩ	40MΩ	40MΩ	60MΩ	60MΩ	50MΩ	34MΩ	60MΩ
Continuity buzzer		-	✓	✓	✓	✓	✓	✓	✓	✓	✓	✓	✓
Battery test		-	✓	-	-	-	-	-	-	-	-	-	-
Diode test		-	-	-	✓	✓	✓	✓	✓	✓	✓	-	✓
Capacitance		-	-	600µF	1000µF	1000µF	100µF	100µF	4000µF	1000µF	50mF	-	40µF
Frequency	Hz	-	-	-	ACV 99.99kHz	ACA 9.999kHz ACV 99.99kHz	200kHz	10MHz	10MHz	99.99kHz	99.99kHz	ACA 10kHz ACV 300kHz	ACA 400Hz ACV 300kHz
Duty cycle ratio	DUTY	-	-	-	✓	✓	✓	✓	✓	-	✓	-	-
Temperature	°C	-	✓	-	-	-	-	-	(1011)	✓	✓	-	-
Decibel	dB	✓	-	-	-	-	-	-	-	-	✓	-	-
Low power-Ω	LP-Ω	-	-	-	-	-	-	-	-	-	✓ (1062)	-	-
<b>Function</b>													
Dual display		-	-	-	-	-	-	-	-	✓	✓	-	-
Bar graph		-	-	-	-	-	-	-	✓	✓	✓	✓	✓
Back light		-	-	-	✓	✓	✓	-	-	✓	✓	-	-
Data hold	DATA HOLD	-	-	-	✓	✓	✓	✓	✓	✓	✓	✓	✓
Auto hold		-	-	-	-	-	-	-	-	✓	✓	-	-
Peak hold	PEAK HOLD	-	-	-	-	-	-	-	-	-	✓ (1062)	-	-
Max/Min/Ave	Max/Min Ave	-	-	-	(No Ave)	(No Ave)	-	-	(No Ave)	(1052)	✓	-	-
REL	REL	-	-	✓	✓	✓	✓	✓	✓	✓	✓	-	-
Manual memory		-	-	-	-	-	-	-	-	✓ (1052)	✓	-	-
Logging memory		-	-	-	-	-	-	-	-	✓ (1052)	✓	-	-
Communication	USB	-	-	-	-	-	-	-	-	✓ (1052)	✓	-	-
<b>Other</b>													
Operating temperature		0 - 40°C	0 - 40°C	0 - 40°C	0 - 40°C	0 - 40°C	0 - 40°C	0 - 40°C	0 - 40°C	-10 - 55°C	-20 - 55°C	0 - 40°C	0 - 40°C
Measurement categories		-	CAT III 300V CAT II 600V	CAT III 300V CAT II 600V	CAT IV 300V CAT III 600V CAT II 1000V	CAT IV 300V CAT III 600V	CAT III 600V	CAT III 300V	CAT III 300V CAT II 600V	CAT IV 600V CAT III 1000V	CAT IV 600V CAT III 1000V	CAT III 300V CAT II 600V	CAT III 300V CAT II 600V
Power source		R6 × 2, 6F22 × 1	R6 × 2	CR2032 × 1	R03 × 2	R03 × 2	LR-44 × 2	R6 × 2	R6 × 2	R6 × 4	R6 × 4	R03 × 2	R03 × 2
Dimensions (L)x(W)x(D)mm		150×100×47	140×94×39	126×85×18	155×75×40*2	155×75×35*1 155×75×40*2	190×39×31	161×82×50	161×82×50	192×90×49	192×90×49	128×84×24(2000A) 128×92×27(2001A)	128×92×27
Weight(Approx.)		330g	280g	135g	250g	250g	100g	280g	280g	560g	560g	210g(2000A) 220g(2001A)	220g
Accessories	Test leads	7066A	7066A	-	7066A	7066A	-	7066A	7066A 8216(1011)	7220A	7220A	-	-
	Fuse	8901 × 2	8923 × 2	-	-	8919 × 1	-	8923 × 1 8919 × 1	8918 × 1 8919 × 1	8926 × 1 8927 × 1	8926 × 1 8927 × 1	-	-
	Case	-	9103	9188	-	9097	9130	-	-	-	-	-	-

\*1 With flat-type holder

\*2 With wing-type holder



# MULTIMETERS



## KEW 1020R/1021R



- Accurate reading with True RMS
- Large display with 6000 counts and Backlight
- MIN/MAX function
- Rugged and reliable
- Enhanced current measuring function using an external clamp sensor
- Sensor mode (with clamp sensor)
- Ergonomic design
- Safety Standard IEC 61010-1 CAT IV 300V / CAT III 600V (1020R and 1021R) / CAT II 1000V (1020R)



photo : 1020R

photo : 1021R

	1020R	1021R
DC V	6.000/60.00/600.0/1000V(auto range) ±0.5%rdg±3dgt(6/60/600V) ±0.8%rdg±3dgt(1000V)	6.000/60.00/600.0V(auto range) ±0.5%rdg±3dgt
DC mV	600.0mV ±1.5%rdg±3dgt	
DC Clamp Sensor	60.00/200.0A(auto range) ±1.5%rdg±3dgt + Sensor accuracy	
AC V	6.000/60.00/600.0/1000V(auto range) ±1.0%rdg±3dgt [40 - 500Hz] (6/60/600V) ±1.3%rdg±3dgt [40 - 500Hz] (1000V)	6.000/60.00/600.0V(auto range) ±1.0%rdg±3dgt [40 - 500Hz]
AC mV	600.0mV ±2.0%rdg±3dgt [40 - 500Hz]	
AC Clamp Sensor	60.00/200.0A(auto range) ±2.0%rdg±3dgt + Sensor accuracy [40 - 500Hz]	
DC A	—	6.000/10.00A(auto range) ±1.5%rdg±3dgt
AC A	—	6.000/10.00A(auto range) ±1.5%rdg±3dgt [40 - 500Hz]
Ω	600.0Ω/6.000/60.00/600.0kΩ/6.000/40.00MΩ (auto range) ±0.5%rdg±5dgt(600Ω), ±0.5%rdg±2dgt(6/60/600kΩ/6MΩ), ±1.5%rdg±3dgt(40MΩ)	
Continuity buzzer	600Ω (Buzzer sounds below 90Ω)	
Diode test	Open-loop Voltage:<3.0V	
Capacitance	60.00/600.0nF/6.000/60.00/600.0/1000μF ±2.0%rdg±5dgt(60n/600nF), ±5%rdg±5dgt(6/60/600/1000μF)	
Frequency	ACV 99.99/999.9Hz/9.999/99.99kHz ±0.1%rdg±3dgt ACA 99.99/999.9Hz/9.999kHz ±0.1%rdg±3dgt*1	
DUTY	10.0 - 90.0% ±1.0%rdg±3dgt [50/60Hz]	
Applicable Standards	IEC 61010-1 CAT IV 300V / CAT III 600V / CAT II 1000V *2 Pollution degree 2, IEC 61010-2-033, IEC 61010-031 IEC 61326-2-2(EMC), IEC 60529 IP40	
Power source	R03(AAA)(1.5V) × 2	
Dimensions	155(L) × 75(W) × 40(D) mm (with Wing-type holder)	
Weight	250g approx. (including batteries and Wing-type holder)	
Accessories	Wing-type holder 7066A(Test leads) R03(AAA) × 2, Instruction manual	Wing-type holder, Flat-type holder, 7066A(Test leads) 9097(Carrying case), 8919(Ceramic fuse[10A/600V]) × 1(included) R03(AAA) × 2, Instruction manual
Optional Accessories	7234(Alligator clip), 8161(AC Clamp sensor), 8115(AC/DC Clamp sensor), 9189(Magnet hanger strap)	

\*1 1021R only \*2 1020R only

## Accessories

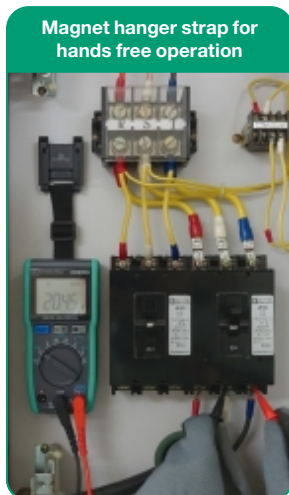

Magnet hanger strap for hands free operation

wing-type Holder

MODEL 7066A  
Test leads

Flat-type Holder

1021R Only

MODEL 8919  
Fuse 10A/600V  
(Included)

MODEL 9097  
Carrying case

## Optional Accessories

MODEL 7234  
Alligator clip

KEW 8161  
AC Clamp sensor

MODEL 9189  
Magnet hanger strap

KEW 8115  
AC/DC Clamp sensor

# MULTIMETERS



## MODEL 1009

DC V AC V Ω Hz DUTY DATA HOLD REL AUTO POWER OFF

- Display : 3999 counts.
- Auto range and manual range selector provided. (with range hold feature)
- Resistance range provides audible continuity test.
- Automatically turns power off in about 30 minutes to conserve battery life.
- Direct current measurement up to 10A AC and DC.



## KEW 1011/1012

1012 TRUE RMS DC V AC V Ω Hz DUTY °C DATA HOLD MAX/MIN REL AUTO POWER OFF

- 6040 counts with Bar Graph display
- MIN/MAX function enables to record min & max value
- REL(relative value) function
- Temperature measurement, selectable for °C and °F (KEW 1011)
- True RMS can measure and indicate distorted waveforms (KEW 1012)
- DUTY function



photo : 1012

	1009	1011	1012
DC V	400mV/4/40/400/600V ±0.6%rdg±4dgt*	600.0mV/6.000/60.00/600.0/600V ±0.5%±2dgt*	
AC V	400mV/4/40/400/600V ±1.3%rdg±4dgt*	6.000/60.00/600.0/600V ±1.0%±3dgt*	6.000/60.00/600.0/600V ±1.2%±3dgt*
DC A	400/4000µA/40/400mA/4/10A ±1.0%rdg±4dgt*	600/6000µA/60/600mA/6/10A ±1.2%±3dgt*	
AC A	400/4000µA/40/400mA/4/10A ±2.0%rdg±4dgt*	600/6000µA/60/600mA/6/10A ±1.5%±4dgt*	
Ω	400/4/40/400k/4/40MΩ ±1.0%rdg±4dgt	600/6/60/600k/6/60MΩ ±1.0%±2dgt*	
Continuity buzzer	400Ω(Buzzer sounds below 100Ω)	0 - 600Ω(Buzzer sounds below 100Ω)	
Diode test	1.5V Release Voltage : Approx. 0.4mA test current	2.8V release voltage : Approx. 0.4mA test current	
Capacitance test	40/400nF/4/40/100µF	40/400nF/4/40/400µF	
Frequency	5.12/51.2/512Hz/5.12/51.2/512kHz/5.12/10MHz	10/100/1000Hz/10/100/1000kHz/10MHz	
DUTY	0.1 - 99.9%(Pulse width/Pulse period) ±2.5%±5dgt	0.1 - 99.9%(Pulse width/Pulse period) ±2.0%±2dgt( - 10kHz)	
Temperature	—	-50 - 300°C(-58 - 572°F)(with the use of Temperature probe 8216)	—
Applicable Standards	IEC 61010-1 CAT III 300V, IEC 61326-1	IEC 61010-1 CAT III 300V, CAT II 600V, IEC 61326	
Power source	R6(AA)(1.5V) × 2 (Auto power off : approx. 30 minutes)	R6(AA)(1.5V) × 2 (Auto power off : approx. 15 minutes)	
Dimensions	161(L) × 82(W) × 50(D)mm	161(L) × 82(W) × 50(D)mm	
Weight	280g approx.	280g approx.	
Accessories	7066A(Test leads), 8919(Ceramic fuse[10A/600V]) × 1 (included), 8923(Ceramic fuse [0.5A/600V]) × 1 (included), R6(AA) × 2, Instruction manual	7066A(Test leads), 8216(K-type temperature probe)(1011 Only), 8918(Ceramic fuse[0.8A/600V]) × 1 (included), 8919(Ceramic fuse[10A/600V]) × 1 (included), R6(AA) × 2, Instruction manual	
Optional	7234(Alligator clip), 9095(Carrying case)		

\*Basic accuracy : For the detailed accuracy, please see our product catalogue on our website.



## KEW 1109S

DC V AC V Ω dB

- Mirrored scale for easy and accurate reading.
- Output terminal to cut off DC component when measuring AC voltage.
- Safety designed input terminals and test leads.

	1109S
DC V	0.1/0.5/2.5/10/50/250/1000V(20kΩ/V) ±3% of FS
AC V	10/50/250/1000V(9kΩ/V) ±3% of FS
DC A	50µA/2.5/25/250mA ±3% of FS
Ω	2/20kΩ/2/20MΩ ±3% of scale length
Decibel	-10 - +62dB
hFE	0 - 1000(Ω × 10) ±3% of scale length
Power source	R6(AA)(1.5V) × 2, 6F22(9V) × 1
Dimensions	150(L) × 100(W) × 47(D)mm
Weight	330g approx.
Accessories	7066A(Test leads), 8901(Fuse[0.5A/250V]) × 1 (included), 1 (spares) R6(AA) × 2, 6F22 × 1, Instruction manual
Optional	9168(Carrying case)



## MODEL 1110

DC V AC V Ω °C

- High sensitivity DC20kΩ/V.
- 1m drop-proof heavy duty design.
- Can measure line voltage up to AC 600V. (Voltage to ground MAX AC 300V) (Protected by 600V ceramic fuse against accidental overload)
- Continuity buzzer, battery check, LED check function.
- Skeleton type robust and clear case with carrying handle furnished as standard accessory.

	1110
DC V	0.3V(16.7kΩ/V) ±3% of FS 3/12/30/120/300/600V(20kΩ/V) ±3% of FS
AC V	12V(9kΩ/V) ±4% of FS 30/120/300/600V(9kΩ/V) ±3% of FS
DC A	60µA/30/300mA ±3% of FS
Ω	3/30/300kΩ ±3% of scale length
Continuity buzzer	Buzzer sounds below 100Ω
Battery Test	1.5V(0.7 - 2V) ±3% of FS (10Ω load)
Temperature	Note: The MODEL1110 includes a temperature measurement scale, but it is not available for new customers due to the discontinuation of the Temperature Probe 7060.
LED	10mA approx. at 0Ω (at 3V of battery voltage)
Applicable Standards	IEC 61010-1 CAT III 300V /CAT II 600V, IEC 61326-1
Power source	R6(AA)(1.5V) × 2
Dimensions	140(L) × 94(W) × 39(D)mm
Weight	280g approx.
Accessories	7066A(Test leads), 8923(Fuse[500mA/600V]) × 1 (included), 1 (spares) R6(AA) × 2, 9103(Carrying case), Instruction manual



# DIGITAL MULTIMETERS

## KEW 1019R

True RMS DC AC V Ω ( ))) ← REL AUTO POWER SAVE



	1019R
DC V	600.0mV/6.000/60.00/600.0V(Input impedance :10MΩ) ±0.8%rdg±5dgt(600.0mV/6.000/60.00V) ±1.0%rdg±5dgt(600.0V)
AC V	6.000/60.00/600.0V(Input impedance:10MΩ) ±1.3%rdg±5dgt(6.000/60.00V)(50/60Hz) ±1.7%rdg±5dgt(6.000/60.00V)(45 - 500Hz) ±1.6%rdg±5dgt(600.0V)(50/60Hz) ±2.0%rdg±5dgt(600.0V)(45 - 500Hz)
Ω	600.0Ω/6.000/60.00/600.0kΩ/6.000/40.00MΩ ±1.0%rdg±5dgt(600.0Ω/6.000/60.00/600.0kΩ/6.000MΩ) ±2.5%rdg±5dgt(40.00MΩ)
Continuity buzzer	600Ω(Buzzer sounds below 60Ω)
Capacitance test	6.000/60.00/600.0nF/6.000/60.00/600.0μF ±3.5%rdg±5dgt(6.000nF) ±3.5%rdg±10dgt(60.00nF) ±3.5%rdg±5dgt(600.0nF/6.000/60.00μF) ±4.5%rdg±5dgt(600.0μF)
Applicable Standards	IEC 61010-1 CAT III 300V,CAT II 600V IEC 61010-2-033, IEC 61010-031, IEC 61326-2-2
Power source	CR2032(3V) × 1 (Auto power off : approx. 15 minutes)
Dimensions	126(L) × 85(W) × 18(D)mm (including hard case)
Weight	135g approx. (including battery and hard case)
Accessories	9188(Hard case), CR2032(3V) × 1, Instruction manual



- True-RMS Measurements.
- Large display.
- Sturdy measurement code.
- Simple range composition.
- Easy-to-use smart structure hard case.
- DCV, ACV, Ω capacitor Measurement.
- Complies with IEC 61010-1 CAT III 300V, CAT II 600V.

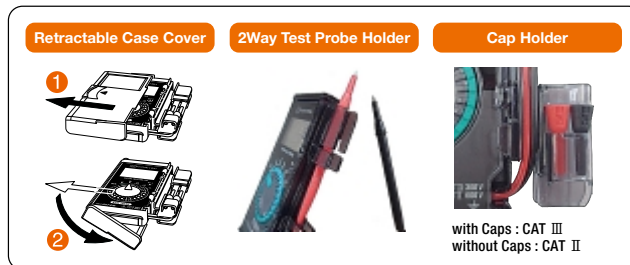

## KEW 1030

DC AC V Ω ( ))) → ← Hz  
DUTY ☀ DATA HOLD REL AUTO POWER OFF



- Compact in Size, Light in Weight and Simple in Use
- Double moulding provides comfortable and good feeling in hand
- Penlight illuminates brightly the point to be measured, even in dark place
- Backlight LCD is highly visible, even in darkness
- Unique wrapping mechanism for test lead in the rear side compartment

	1030
DC V	400m/4/40/400/600V(5 range auto) ±0.8%rdg±5dgt(400mV - 400V) ±1.0%rdg±5dgt(600V)
AC V	4/40/400/600V(4 range auto) ±1.3%rdg±5dgt(4/40V)(50/60Hz) ±1.6%rdg±5dgt(400/600V) (50/60Hz)
Ω	400/4k/40k/400k/4M/40MΩ(6 range auto) ±1.0%rdg±5dgt(400Ω - 4MΩ) ±2.5%rdg±5dgt(40MΩ)
Continuity buzzer	Buzzer sounds when resistance is 120Ω or less.
Diode test	Test voltage approx. 0.3 - 1.5V
Capacitance test	50n/500n/5μ /50μ /100μF(5 range auto) ±3.5%rdg±10dgt(50nF) ±3.5%rdg±5dgt(500n - 50μF) ±4.5%rdg±5dgt(100μF)
Frequency	5/50/500/5k/50k/200kHz ±0.1%rdg±5dgt
Duty	0.1 - 99.9% ±2.5%rdg±5dgt (Pulse width / Pulse cycle)
Applicable Standards	IEC 61010-1 CAT III 600V IEC 61010-031, IEC 61326-1(EMC)
Power source	Button type battery LR44(SR44)(1.5V) × 2 (Auto power off : approx. 30 minutes)
Dimensions	190(L) × 39(W) × 31(D)mm
Weight	Approx. 100g (including batteries)
Accessories	9130(Carrying case), LR44(1.5V) × 2, Instruction manual



### Protection cover prevents unforeseen accident

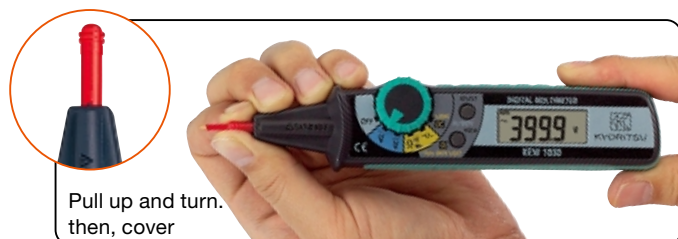

### Wrapping mechanism for test lead in rear side compartment

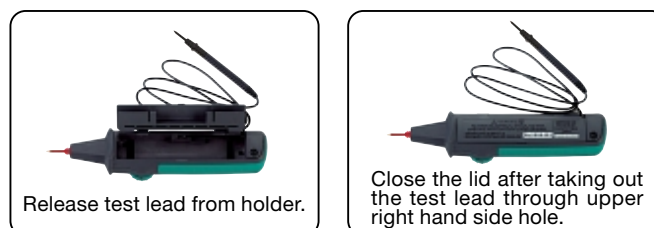

# DIGITAL MULTIMETERS



photo : 1052

photo : 1062

## High Accuracy, High Performance and Reliable Measurements

- Top accuracy  
0.02% basic DC accuracy for 1061/1062.  
0.09% basic DC accuracy for 1051/1052.
- Dual display  
1061/1062: 50,000 counts, Bar graph with 51 segments. White back light display.  
1051/1052: 6,000 counts, Bar graph with 31 segments. White back light display.
- True-RMS Measurements
- Wide AC Frequency bandwidth from 10Hz to 100kHz \*only for 1062

## KEW 1051/1052 KEW 1061/1062

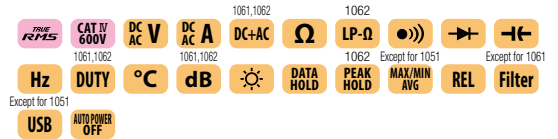

- True-RMS or MEAN value detection mode can be selected \*only for 1052, 1062
- DC+AC TRMS Measurement \*only for 1061, 1062  
AC and DC values are displayed simultaneously via dual display.
- Fast Peak Hold response time of 250µs \*only for 1062
- Low-pass filter \*except for 1061
- Low Power-Ω measurements \*only for 1062
- User calibration function

## Safety design for industrial use

- Complies with IEC 61010-1 CAT IV 600V, CAT III 1000V
- Terminal shutter to prevent incorrect test leads' insertion in current terminals
- Very wide operating temperature range  
From -20 to +55°C for 1061/1062  
From -10 to +55°C for 1051/1052

## Reliable support for data management

### \*except for 1051

- Large data internal memory
- Download data and Live Monitoring on a PC via the USB interface (Option for USB Communication set)

	1051	1052	1061	1062
Detection mode	RMS	MEAN/RMS (switch)	RMS	MEAN/RMS (switch)
DC V	600.0mV/6.000/60.00/600.0/1000V (Input impedance: 10MΩ [600mV/60/600/1000V], 11MΩ [6V]) ±0.09%rdg±2dgt *		50.000/500.00/2400.0mV/5.0000/50.000/500.00/1000.0V (Input impedance: Approx. 100MΩ [50/500/2400mV], 10MΩ [5/50/500/1000V]) ±0.02%rdg±2dgt *	
AC V [RMS]	600.0mV/6.000/60.00/600.0/1000V (Input impedance: 10MΩ<200pF [600mV], 11MΩ<50pF [6V], 10MΩ<50pF [60/600/1000V]) ±0.5%rdg±5dgt *		50.000*/500.00mV/5.0000/50.000/500.00/1000.0V (Input impedance: 11MΩ<50pF [50/500mV/5V], 10MΩ<50pF [50/500/1000V]) ±0.7%rdg±30dgt * ±0.4%rdg±30dgt *	
AC V [MEAN]	-	600.0mV/6.000/60.00/600.0/1000V (Input impedance: 10MΩ<200pF [600mV], 11MΩ<50pF [6V], 10MΩ<50pF [60/600/1000V]) ±0.5%rdg±5dgt *	-	50.000/500.00mV/5.0000/50.000/500.00/1000.0V (Input impedance: 11MΩ<50pF [50/500mV/5V], 10MΩ<50pF [50/500/1000V]) ±1%rdg±30dgt *
DCV+ACV	-	-	5.0000/50.000/500.00/1000.0V (Input impedance: 11MΩ<50pF [5V], 10MΩ<50pF [50/500/1000V]) ±1%rdg±10dgt *	±0.5%rdg±10dgt *
DC A	600.0/6000µA/60.00/440.0mA/6.000/10.00A ±0.2%rdg±2dgt *		500.00/5000.0µA/50.000/500.00mA/5.0000/10.000A ±0.2%rdg±5dgt *	
AC A [RMS]	600.0/6000µA/60.00/440.0mA/6.000/10.00A ±0.75%rdg±5dgt *		500.00/5000.0µA/50.000/500.00mA/5.0000/10.000A ±1%rdg±20dgt * ±0.75%rdg±20dgt *	
AC A [MEAN]	-	-	-	500.00/5000.0µA/50.000/500.00mA/5.0000/10.000A ±1.5%rdg±20dgt *
DCA+ACA	-	-	500.00/5000.0µA/50.000/500.00mA/5.0000/10.000A ±1.5%rdg±10dgt *	±1%rdg±10dgt *
Ω	600.0Ω/6.000/60.00/600.0kΩ/6.000/60.00MΩ ±0.4%rdg±1dgt *		500.00Ω/5.0000/50.000/500.00kΩ/5.0000/50.000MΩ ±0.1%rdg±2dgt * ±0.05%rdg±2dgt *	
LowPower-Ω	-	-	-	5.000/50.00/500.0kΩ/5.000MΩ ±0.2%rdg±3dgt *
Continuity buzzer	600.0Ω (The buzzer turns on for resistances lower than 50±30Ω)		500.0Ω (The buzzer turns on for resistances lower than 100±50Ω)	
Diode test	2.000V ±1%rdg±2dgt Open circuit voltage: <3.5V (Approx. 0.5mA Measuring Current)		2.4000V ±1%rdg±2dgt Open circuit voltage: <5V (Approx. 0.5mA Measuring Current)	
Capacitance	10.00/100.0nF/1.000/10.00/100.0/1000µF ±2%rdg±5dgt *		5.000/50.00/500.0nF/5.000/50.00/500.0µF/5.000/50.00mF ±1%rdg±5dgt *	
Frequency	10.00 - 99.99/90.0 - 999.9Hz/0.900 - 9.999/9.00 - 99.99kHz ±0.02%rdg±1dgt *		2.000 - 9.999/9.00 - 99.99/90.0 - 999.9Hz/0.900 - 9.999/9.00 - 99.99kHz ±0.02%rdg±1dgt *	
DUTY	-	-	10 - 90% ±1%rdg	
Temperature	-50 - 600°C ±2%rdg±2°C (with the use of K-type Temperature probe)		-200 - 1372°C ±1%rdg±1.5°C (with the use of K-type Temperature probe)	
Applicable Standards	IEC 61010-1 CAT IV 600V, CAT III 1000V Pollution degree 2, IEC 61326-1 (EMC)			
Power source	R6/LR6(1.5V) × 4 (Auto power off: approx. 20 minutes)			
Dimensions	192(L) × 90(W) × 49(D) mm			
Weight	Approx. 560g (including batteries)			
Accessories	7220A (Test Leads), 8926(Fuse [440mA/1000V]) × 1 (included), 8927(Fuse [10A/1000V]) × 1 (included), LR6 × 4, Instruction manual			

\*Basic accuracy : For the detailed accuracy, please see our product catalogue on our website.



# DIGITAL MULTIMETERS

## Reliable support for data management

※ except for 1051

### Large internal memory to store test data

- KEW1062: 10,000 data in Logging mode, 100 data manually saved.
- KEW1061: 1,000 data in Logging mode, 100 data manually saved.
- KEW1052: 1,600 data in Logging mode, 100 data manually saved.
- Logging interval can set from 1 sec. to 30 min.

### Test data can be transferred to a PC or directly to a Printer\*

- Real-time data can be transferred and shown on a PC.
- Real-time transferring permits the saving of a considerable amount of data on a PC.
- Stored data of internal memory can be monitored by PC.

### Data management with the software DMM Application\*

- Stored data of internal memory can be monitored by PC.
- List of measured data can be converted into Graph.
- Data can be transferred to Excel\*\* and saved as CSV file.

\*Optional accessories are required.

\*\*Excel is a registered trademark of Microsoft in the USA.

### Data analysis with Excel

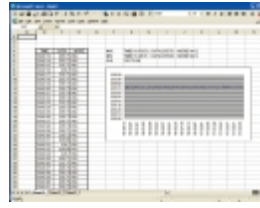

### Printer output

L0000 N+12.539 VDC  
L0001 N+12.532 VDC  
L0002 N+12.532 VDC  
L0003 N+12.529 VDC  
L0004 N+12.532 VDC  
L0005 N+12.538 VDC  
L0006 N+12.541 VDC  
L0007 N+12.546 VDC  
L0008 N+12.552 VDC  
L0009 N+12.557 VDC  
L0010 N+12.555 VDC  
L0011 N+12.554 VDC  
L0012 N+12.553 VDC

- Printed items (from the left)
- L: Logging memory
  - 4 digit numbers: Data number
  - N: Normal measurement
  - (O: at "OL" display)
  - (B: at "Battery warning" display)
  - 5 digit numbers: Measurement
  - VDC: Unit (VDC is DC Voltage)



### DMM Application software

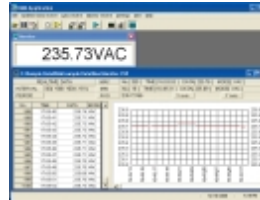

### System requirements

- OS: Windows® 11/10/8.1/8
- Display: XGA (Resolution 1024 x 768 dots) or more
- Hard-disk: Space required 10Mbyte or more
- Others: With CD-ROM drive and USB port

\* Windows® is a registered trademark of Microsoft in the United States.

## Optional Accessories

Description	MODEL	Contents
Alligator Clip	7234	CAT IV 600V, CAT III 1000V 1set
USB Communication set	8241	USB adaptor+USB cable+DMM Software
Thermocouple Type K	8405	-40°C - 500°C (Surface type, Point material: Ceramic)
	8406	-40°C - 500°C (Surface type)
	8407	-40°C - 700°C (Liquid, Semi-solid)
	8408	-40°C - 600°C (Air, Gas)
Clamp sensor	8115	Surface type
	8121	AC 100A
	8122	AC 500A
	8123	AC 1000A
	8146	AC 30A
	8147	AC 70A
Banana φ4mm Adjuster Plug	7146	length :190mm
Carrying case	9154	Soft case(for the main unit with test leads and communication cable)

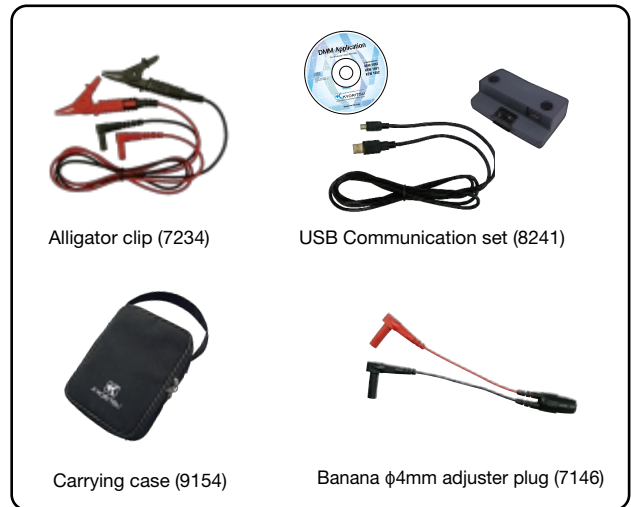

## Thermocouple Type K Specification

MODEL	Usage	Measurement temperature	Tolerance (°C) (t: Measured temperature)	Response speed
8405	Surface type (Point material: Ceramic)	-40°C - 500°C	±2.5 °C (-40 - 332°C), ±0.0075 × t (333 - 500°C)	approx. 1.8 Sec.
8406				approx. 1.0 Sec.
8407	Liquid, Semi-solid	-40°C - 700°C	±2.5 °C (-40 - 332°C), ±0.0075 × t (333 - 700°C)	1 Sec. or less
8408	Air, Gas	-40°C - 600°C	±2.5 °C (-40 - 332°C), ±0.0075 × t (333 - 600°C)	0.4 Sec.

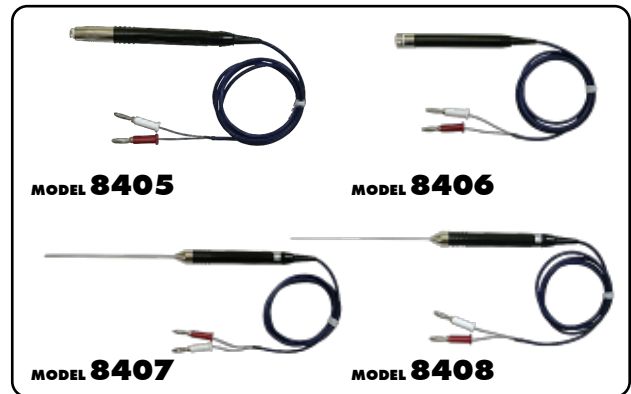

## Clamp sensor Specification

	AC/DC current sensor	AC current sensor				Leakage & AC current sensor		
	8115	8121*	8122*	8123*	8146*	8147*	8148*	
Appearance								
Conductor size	φ12mm	φ24mm	φ40mm	φ55mm	φ24mm	φ40mm	φ68mm	
Rated current	AC 130A / DC 180A	AC 100A	AC 500A	AC 1000A	AC 30A	AC 70A	AC 100A	
Output voltage	AC 10mV/A, DC 10mV/A	AC 500mV/100A	AC 500mV/500A	AC 500mV/1000A	AC 1500mV/30A	AC 3500mV/70A	AC 5000mV/100A	
Accuracy (50/60Hz)	AC ±1.0%rdg±0.4mV DC ±1.0%rdg±0.4mV (This accuracy is defined after a zero-adjustment)	±2.0%rdg±0.3mV			0 - 15A ±1.0%rdg±0.1mV 15 - 30A ±5.0%rdg	0 - 40A ±1.0%rdg±0.1mV 40 - 70A ±5.0%rdg	0 - 80A ±1.0%rdg±0.1mV 80 - 100A ±5.0%rdg	
Frequency range	40Hz - 1kHz							
Dimensions	127(L)×42(W)×22(D)mm	97(L)×59(W)×26(D)mm	128(L)×81(W)×36(D)mm	170(L)×105(W)×48(D)mm	100(L)×60(W)×26(D)mm	128(L)×81(W)×36(D)mm	186(L)×129(W)×53(D)mm	
Weight	approx. 160g	approx. 150g	approx. 260g	approx. 360g	approx. 150g	approx. 240g	approx. 510g	

\*Banana φ4mm adjuster plug(7146) is required to connect the clamp sensor to the DMM.

# DIGITAL MULTIMETERS

**KEW MATE 2000A**

Ø6

MAX 60A

**KEW MATE 2001A**

Ø10

MAX 100A

**KEW MATE 2012RA**

Ø12

MAX 120A

TRUE RMS

→ ←



Video

- Capable of measuring AC and DC currents with OPEN CLAMP SENSOR. 60A(2000A)/100A(2001A)/120A(2012RA)
- Increase cable strength with new rubber protective.
- Test probe can be fixed to the holster.
- Can measure AC/DC current and voltage.
- Pocket size and heavy duty design.
- With test lead cap to protect from short circuit accident.
- The open jaws are thin, perfect to clamp wires even in tight spaces.

DC V AC V DC A AC A Ω Hz DATA HOLD AUTO POWER SAVE



photo : 2012RA



New Cable rubber protective.



photo : 2000A



photo : 2001A



	2000A	2001A	2012RA
DC V	340.0mV/3.400/34.00/340.0/600V (input impedance : approx.10MΩ) ±1.5%rdg±4dgt		600.0mV/6.000/60.00/600.0V (input impedance : approx.10MΩ) ±1.0%rdg±3dgt
AC V	3.400/34.00/340.0/600V (input impedance : approx.10MΩ) ±1.5%rdg±5dgt (50 - 400Hz)		6.000/60.00/600.0V (input impedance : approx.10MΩ) ±1.5%rdg±5dgt (45 - 400Hz)
DC A	60.0A ±2.0%rdg±5dgt	100.0A ±2.0%rdg±5dgt	60.00/120.0A ±2.0%rdg±8dgt (60A) ±2.0%rdg±5dgt (120A)
AC A	60.0A ±2.0%rdg±5dgt (50/60Hz)	100.0A ±2.0%rdg±5dgt(50/60Hz)	60.00/120.0A ±2.0%rdg±5dgt (45 - 65Hz)
Ω	340.0Ω/3.400/34.00/340.0kΩ/3.400/34.00MΩ ±1.0%rdg±3dgt (340Ω/3.4/34/340kΩ) ±5.0%rdg±5dgt (3.4MΩ) ±15.0%rdg±5dgt (34MΩ)		600.0Ω/6.000/60.00/600.0kΩ/6.000/60.00MΩ ±1.0%rdg±5dgt (600Ω/6/60/600kΩ) ±2.0%rdg±5dgt (6MΩ) ±3.0%rdg±5dgt (60MΩ)
Continuity buzzer	Buzzer sounds below 30±10Ω (Continuity buzzer works on 340Ω range only)		Buzzer sounds below 35±25Ω
Diode test	-	-	2.000V ±3.0%rdg±5dgt Open-loop voltage:approx.2.7V
Capacitance	-	-	400.0nF/4.000/40.00µF ±2.5%rdg±10dgt
Frequency	AC A	3.400/10.00kHz ±0.1%rdg±1dgt	99.99/400.0Hz ±0.2%rdg±2dgt (100Hz) ±0.1%rdg±1dgt (400Hz)
	AC V	3.400/34.00/300.0kHz ±0.1%rdg±1dgt	99.99/999.9Hz/9.999/99.99/300.0kHz ±0.2%rdg±2dgt (100Hz) ±0.1%rdg±1dgt (1000Hz/10/100/300kHz)
	Input sensitivity	Current:more than 15A Voltage:more than 30V	Current:more than 25A Voltage:more than 30V
Conductor size	φ6mm max	φ10mm max	φ12mm max
Applicable standards	IEC 61010-1 CAT III 300V, CAT II 600V Pollution degree 2, IEC 61010-031, IEC 61010-2-032, IEC 61326-1		
Power source	R03(AAA)(1.5V)×2 *Continuous measuring time : approx. 45hours (Auto power save:approx.10minutes)		R03(AAA)(1.5V)×2 *Continuous measuring time: DC V:approx.150hours,AC A:approx.25hours (Auto power save:approx.15minutes)
Dimensions	128(L)×87(W)×24(D) mm	128(L)×92(W)×27(D) mm	
Weight	210g approx.(including batteries)	220g approx.(including batteries)	
Accessories	R03(AAA)×2,Instruction manual		
Optional	9107(Carrying case[Soft])		



Test Probe can be fixed to the holster



Forklift maintenance



Automobile maintenance





# CLAMP METERS



# CLAMP METERS

Selection Guide of Clamp Meters

Selection Guide of Clamp Meters												
	AC Clamp Meters											Fork Current Tester
	2031	2007R	2117R	2127R	2200	2200R	2002PA	2002R	2204R	2210R	2300R	
Appearance												
Conductor size $\Phi$	$\phi$ 24mm	$\phi$ 33mm	$\phi$ 33mm	$\phi$ 33mm	$\phi$ 33mm	$\phi$ 33mm	$\phi$ 55mm	$\phi$ 55mm	$\phi$ 70mm	$\phi$ 150mm	$\phi$ 10mm	
Display	Digital	Digital	Digital	Digital	Digital	Digital	Digital	Digital	Digital	Digital	Digital	
Detection method	-	✓	✓	✓	-	✓	-	✓	✓	✓	✓	
Frequency response	40 - 1kHz	40 - 400Hz	40 - 1kHz	40 - 1kHz	45 - 65Hz(ACA) 45 - 500Hz(ACV)	40 - 1kHz(ACA) 45 - 500Hz(ACV)	40 - 1kHz	40 - 1kHz	45 - 500Hz	45 - 500Hz	DC 50/60Hz	
<b>Measurement</b>												
<b>AC A</b>	Max	200A	1000A	1000A	1000A	1000A	1000A	2000A	2000A	400A	3000A	100A
	Resolution	0.01A	0.1A	0.01A	0.01A	0.01A	0.01A	0.1A	0.1A	0.001A	0.01A	0.1A
	Accuracy	$\pm 2\%R \pm 5D$	$\pm 1.5\%R \pm 4D$	$\pm 1.5\%R \pm 4D$	$\pm 1.5\%R \pm 4D$	$\pm 1.4\%R \pm 6D$	$\pm 1.5\%R \pm 5D$	$\pm 1\%R \pm 3D$	$\pm 1.5\%R \pm 3D$	$\pm 3\%R \pm 5D$	$\pm 3\%R \pm 5D$	$\pm 2\%R \pm 5D$
<b>DC A</b>	Max	-	-	-	-	-	-	-	-	-	-	100A
	Resolution	-	-	-	-	-	-	-	-	-	-	0.1A
	Accuracy	-	-	-	-	-	-	-	-	-	-	$\pm 2\%R \pm 5D$
AC Voltage <b>AC V</b>	-	600V	60/600V	60/600V	600V	600V	750V	750V	-	-	-	
DC Voltage <b>DC V</b>	-	600V	60/600V	60/600V	600V	600V	1000V	1000V	-	-	-	
Resistance $\Omega$	-	6k $\Omega$	600k $\Omega$	40M $\Omega$	40M $\Omega$	40M $\Omega$	400K $\Omega$	400K $\Omega$	-	-	-	
Continuity buzzer	-	✓	✓	✓	✓	✓	✓	✓	-	-	-	
Frequency <b>Hz</b>	-	-	-	9.999kHz	-	-	-	-	-	-	-	
Duty cycle ratio <b>DUTY</b>	-	-	-	-	-	-	-	-	-	-	-	
Diode test	-	-	-	✓	-	-	-	-	-	-	-	
Capacitance	-	-	-	✓	-	-	-	-	-	-	-	
Temperature $^{\circ}C$	-	-	-	-	-	-	-	-	-	-	-	
<b>Function</b>												
Non contact voltage <b>NCV</b>	-	-	✓	✓	-	-	-	-	-	-	-	✓
Back light	-	-	-	✓	-	-	-	-	✓	✓	-	-
Data hold <b>DATA HOLD</b>	✓	✓	✓	✓	✓	✓	✓	✓	✓	✓	✓	✓
Peak hold <b>PEAK HOLD</b>	-	-	-	✓	-	-	✓	✓	-	-	-	-
Max/Min <b>MAX/MIN</b>	-	-	-	-	-	-	-	-	✓	✓	-	-
Relative <b>REL</b>	-	-	-	-	-	-	-	-	-	-	-	-
Output <b>OUT PUT</b>	-	-	-	-	-	-	✓	✓	-	-	-	-
<b>Other</b>												
Operating temperature	0 - 40 $^{\circ}C$	0 - 40 $^{\circ}C$	0 - 40 $^{\circ}C$	0 - 40 $^{\circ}C$	0 - 40 $^{\circ}C$	0 - 40 $^{\circ}C$	0 - 40 $^{\circ}C$	0 - 40 $^{\circ}C$	0 - 40 $^{\circ}C$	0 - 50 $^{\circ}C$	0 - 50 $^{\circ}C$	0 - 40 $^{\circ}C$
Measurement categories	CAT III 300V	CAT IV 300V CAT III 600V	CAT IV 300V CAT III 600V	CAT IV 300V CAT III 600V	CAT III 600V(ACA) CAT III 300V(AC/DCV) CAT II 600V(AC/DCV)	CAT IV 300V(ACA) CAT III 600V(ACA) CAT III 300V(AC/DCV) CAT II 600V(AC/DCV)	CAT III 600V CAT II 1000V	CAT III 600V CAT II 1000V	CAT IV 600V CAT III 1000V	CAT IV 600V CAT III 1000V	CAT III 300V	
Power source	LR-44 $\times$ 2	R03/LR03 $\times$ 2	R03/LR03 $\times$ 2	R03/LR03 $\times$ 2	R03/LR03 $\times$ 2	R03/LR03 $\times$ 2	R6 $\times$ 2	R6 $\times$ 2	R03/LR03 $\times$ 2	R03/LR03 $\times$ 2	R03 $\times$ 2	
Dimensions (L) $\times$ (W) $\times$ (D)mm	147 $\times$ 58.5 $\times$ 26	204 $\times$ 81 $\times$ 36	204 $\times$ 81 $\times$ 36	204 $\times$ 81 $\times$ 36	190 $\times$ 68 $\times$ 20	190 $\times$ 68 $\times$ 20	247 $\times$ 105 $\times$ 49	247 $\times$ 105 $\times$ 49	120 $\times$ 70 $\times$ 26 (Display unit)	120 $\times$ 70 $\times$ 26 (Display unit)	161 $\times$ 40 $\times$ 30	
Weight(Approx.)	100g	220g	220g	230g	120g	120g	470g	470g	200g	300g	110g	
Accessories	Test leads	-	7066A	7066A	7066A	7107A	7107A	7107A	7107A	-	-	-
	Fuse	-	-	-	-	-	-	-	-	-	-	-
	Case	9090	9079	9079	9079	9160	9160	9094	9094	9174	9174	9113



# CLAMP METERS

Selection Guide of Clamp Meters

	DC Milliamp Clamp Meter/ Clamp Logger		AC/DC Clamp Meters						Leakage Clamp Meters					
	2500	2510	2010	2033	2046R	2055 2056R	2003A	2009R	2431	2434	2432	2433 2433R	2413F 2413R	
Appearance														
Conductor size	φ6 mm	φ6 mm	φ7.5mm	φ24mm	φ33mm	φ40mm	φ55mm	φ55mm	φ24mm	φ28mm	φ40mm	φ40mm	φ68mm	
Display	Digital	Digital	Digital	Digital	Digital	Digital	Digital	Digital	Digital	Digital	Digital	Digital	Digital	
Detection method	-	-	-	-	✓	✓ (2056R)	-	✓	-	-	-	✓ (2433R)	✓ (2413R)	
Frequency response	DC	DC	DC 40 - 2kHz	DC 20 - 1kHz	DC 40 - 400Hz	DC 40 - 400Hz	DC 40 - 1kHz	DC 20 - 1kHz	40 - 400Hz	40 - 400Hz	20 - 1kHz	20 - 1kHz	40 - 1kHz	
<b>Measurement</b>														
<b>AC A</b>	Max	-	-	20A	300A	600A	1000A	2000A	2000A	200A	100A	100A	400A	1000A
	Resolution	-	-	0.1mA	0.01A	0.1A	0.1A	0.1A	0.1A	0.01mA	0.1mA	0.001mA	0.01mA	0.1mA
	Accuracy	-	-	±1%R±2D	±1%R±4D	±2%R±5D	±2%R±5D	±1.5%R±2D	±1.3%R±3D	±2%R±4D	±2%R±4D	±1%R±5D	±1%R±5D	±1%R±2D(2413R) ±1.8%R±5D(2413F)
<b>DC A</b>	Max	120mA	120mA	20A	300A	600A	1000A	2000A	2000A	-	-	-	-	-
	Resolution	0.01mA	0.01mA	0.001A	0.01A	0.1A	0.1A	0.1A	0.1A	-	-	-	-	-
	Accuracy	±0.2%R±5D	±0.2%R±5D	±1%R±2D	±1%R±4D	±1.5%R±5D	±1.5%R±5D	±1.5%R±2D	±1.3%R±2D	-	-	-	-	-
AC Voltage <b>AC V</b>	-	-	-	-	600V	600V	750V	750V	-	-	-	-	-	
DC Voltage <b>DC V</b>	-	-	-	-	600V	600V	1000V	1000V	-	-	-	-	-	
Resistance <b>Ω</b>	-	-	-	-	60MΩ	60MΩ	4000Ω	4000Ω	-	-	-	-	-	
Continuity buzzer	-	-	-	-	✓	✓	✓	✓	-	-	-	-	-	
Frequency <b>Hz</b>	-	-	-	-	10kHz	10kHz	-	10kHz	-	-	-	-	-	
Duty cycle ratio <b>DUTY</b>	-	-	-	-	✓	✓	-	-	-	-	-	-	-	
Diode test	-	-	-	-	✓	✓	-	-	-	-	-	-	-	
Capacitance	-	-	-	-	✓	✓ (2056R)	-	-	-	-	-	-	-	
Temperature <b>°C</b>	-	-	-	-	✓	✓ (2056R)	-	-	-	-	-	-	-	
<b>Function</b>														
Non contact voltage <b>NCV</b>	-	-	-	-	✓	✓	-	-	-	-	-	-	-	
Back light	✓	✓	-	-	✓	✓	-	-	-	-	-	-	✓ (2413R)	
Data hold <b>DATA HOLD</b>	✓	✓	-	✓	✓	✓	✓	✓	✓	✓	✓	✓	✓	
Peak hold <b>PEAK HOLD</b>	-	-	-	-	✓	✓ (2056R)	✓ (Max)	✓ <sup>*2</sup>	-	-	✓	✓	✓	
Max/Min <b>MAX/MIN</b>	-	-	-	-	✓	✓	-	-	-	-	-	-	-	
Relative <b>REL</b>	-	-	-	-	✓	✓	-	-	-	-	-	-	-	
Output <b>OUT PUT</b>	✓	✓	✓	-	-	-	✓	✓	-	-	-	-	✓	
Filter <b>Filter</b>	-	-	-	-	-	-	-	-	✓	✓	✓	✓	✓	
<b>Other</b>														
Operating temperature	-10 - 50°C	-10 - 50°C	0 - 50°C	0 - 40°C	0 - 40°C	0 - 40°C	0 - 40°C	0 - 40°C	0 - 40°C	0 - 40°C	0 - 40°C	0 - 40°C	0 - 40°C	
Measurement Categories	-	-	-	CAT III 300V	CAT IV 600V	CAT IV 600V	CAT IV 600V CAT III 1000V	CAT IV 600V CAT III 1000V	CAT III 300V	CAT III 300V	CAT III 300V	CAT III 300V	CAT III 300V	
Power source	R6/LR6 × 4	R6/LR6 × 4 <sup>1</sup>	6LR61 × 1	LR-44 × 2	R03 × 2	R03 × 2	R6 × 2	R6 × 2	LR-44 × 2	R03 × 2	R03 × 2	R03 × 2	R03 × 2	6F22 × 1
Dimensions (L)x(W)x(D)mm	111×61×40 (Display unit) 104×34×20 (Sensor)	111×61×46 (Display unit) 104×33×20 (Sensor)	142×64×26 (Display unit) 153×23×18 (Sensor)	147×59×25	243×77×36	254×82×36	250×105×49	250×105×49	149×60×26	169×75×40	185×81×32	185×81×32	250×130×50	
Weight(Approx.)	290g	310g	220g	100g	300g	310g	530g	540g	120g	220g	290g	270g	570g	
Accessories	Test leads	-	-	-	7066A	7066A	7107A	7107A	-	-	-	-	-	
	Case	9096	9096	9095	9090	9094	9094	9094	9090	9097	9097	9097	9094	

\*1 External power is available.

\*2 In the PEAK mode, the auto-ranging feature is disabled and measuring ranges are fixed as follows.

DC / ACA : 0 - 400.0A

DC / ACV : 0 - 400.0V

# DIGITAL CLAMP METERS



CE

## KEW 2007R

TRUE RMS Ø33 MAX 1000A AC A DC AC V Ω  
DATA HOLD AUTO POWER SAVE

- Fully Safety jaw.
- Ergonomic over-molded body gives convenient one-hand operation.
- Large easy-to-read display with 0.1A resolution.
- Accurate reading with True RMS 600/1000A auto-ranging.
- Long battery life.
- Safety Standard IEC 61010-1 CAT IV 300V / CAT III 600V.

	2007R
AC A	600.0/1000A(Auto-ranging) ±1.5%rdg±4dgt[45 - 65Hz] ±2.0%rdg±4dgt[40 - 400Hz]
AC V	600.0V ±1.2%rdg±3dgt[45 - 65Hz] ±1.5%rdg±4dgt[40 - 400Hz]
DC V	600.0V ±1.2%rdg±3dgt
Ω	600.0Ω/6.000kΩ(Auto-ranging) ±1.3%rdg±5dgt[600Ω] ±2.0%rdg±3dgt[6.000kΩ]
Continuity buzzer	600Ω(Buzzer sounds below 90Ω)
Conductor size	φ33mm max.
Applicable Standards	IEC 61010-1 CAT IV 300V, CAT III 600V Pollution degree 2 IEC 61010-031, IEC 61010-2-032, IEC 61010-2-033 IEC 61326-2-2(EMC), IEC 60529 IP40
Power source	R03/LR03(AAA)(1.5V) × 2 <small>*Continuous measuring time : approx. 170 hours (when R03 is used) (Auto power save : approx. 10 minutes)</small>
Dimensions	204(L) × 81(W) × 36(D)mm
Weight	220g approx. (including batteries)
Accessories	7066A(Test leads), 9079(Carrying case) R03(AAA) × 2, Instruction manual

## MODEL 2002PA/2002R



CE

2002R  
TRUE RMS Ø55 MAX 2000A AC A DC AC V Ω  
DATA HOLD PEAK HOLD OUT PUT AUTO POWER SAVE

- Can measure large AC current up to 2000A.
- Peak hold function.
- 55mm-dia large tear drop shaped jaws.
- Minimum resolution 0.1A

photo : 2002R

	2002PA	2002R
AC A	400A(0 - 400A) ±1%rdg±3dgt[50/60Hz] ±2%rdg±3dgt[40Hz - 1kHz] 2000A(0 - 1500A) ±1%rdg±3dgt[50/60Hz] ±3%rdg±3dgt[40Hz - 1kHz] 2000A(1500 - 2000A) ±3.0%rdg[50/60Hz]	400A(0 - 400A) ±1.5%rdg±3dgt[45 - 65Hz] ±2.5%rdg±3dgt[40Hz - 1kHz] 2000A(0 - 1500A) ±2%rdg±5dgt[45 - 65Hz] ±3%rdg±5dgt[40Hz - 1kHz] 2000A(1501 - 2000A) ±4%rdg[50/60Hz]
AC V	40/400/750V ±1%rdg±2dgt[50/60Hz] ±1.5%rdg±3dgt[40Hz - 1kHz]	40/400/750V ±1%rdg±2dgt[45 - 65Hz] ±1.5%rdg±3dgt[40Hz - 1kHz]
DC V	40/400/1000V ±1%rdg±2dgt	40/400/1000V ±1%rdg±2dgt
Continuity buzzer	buzzer sounds below 50±35Ω	buzzer sounds below 50±35Ω
Ω	400Ω/4k/40k/400kΩ ±1.5%rdg±2dgt	400Ω/4k/40k/400kΩ ±1.5%rdg±2dgt
Conductor size	φ55mm max.	φ55mm max.
Frequency response	40Hz - 1kHz	40Hz - 1kHz
Output	Recorder:DC400mV against AC400A DC200mV against AC2000A	Recorder:DC400mV against AC400A DC200mV against AC2000A
Applicable Standards	IEC 61010-1 CAT III 600V, CAT II 1000V IEC 61010-031 IEC 61010-2-032 IEC 61326-1	IEC 61010-1 CAT III 600V, CAT II 1000V IEC 61010-031 IEC 61010-2-032 IEC 61326-1
Power source	R6(AA)(1.5V) × 2 *Continuous measuring time : approx. 150 hours (2002PA) <small>*Continuous measuring time : approx. 80 hours (2002R) (Auto power save : approx. 10 minutes)</small>	R6(AA)(1.5V) × 2 *Continuous measuring time : approx. 150 hours (2002PA) <small>*Continuous measuring time : approx. 80 hours (2002R) (Auto power save : approx. 10 minutes)</small>
Dimensions	247(L) × 105(W) × 49(D)mm	247(L) × 105(W) × 49(D)mm
Weight	470g approx.	470g approx.
Accessories	7107A(Test leads), 9094(Carrying case) R6(AA) × 2, Instruction manual	7107A(Test leads), 9094(Carrying case) R6(AA) × 2, Instruction manual
Optional	7256(Output cord)	7256(Output cord)

## MODEL 2031



CE

Ø24 MAX 200A AC A DATA HOLD AUTO POWER OFF

- Can measure large AC current up to 200A.
- 24mm-dia tear drop shaped jaws.
- Minimum resolution 0.01A

	2031
AC A	20A ±2%rdg±5dgt[50Hz - 1kHz] 200A ±2%rdg±5dgt[50/60Hz] ±3%rdg±10dgt[40Hz - 1kHz]
Conductor size	φ24mm max.
Frequency response	40Hz - 1kHz
Applicable Standards	IEC 61010-1 CAT III 300V
Power source	LR-44(1.5V) × 2 <small>*Continuous measuring time : approx. 100 hours (Auto power off : approx. 10 minutes)</small>
Dimensions	147(L) × 58.5(W) × 26(D)mm
Weight	100g Approx.
Accessories	9090 (Carrying case) LR-44 × 2 Instruction manual

# DIGITAL CLAMP METERS AC

## KEW 2117R

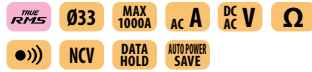

- Fully Safety jaw
- Ergonomic over-molded body gives convenient one-hand operation
- Large easy-to-read display with 0.01A resolution
- Accurate reading with True RMS 60/600/1000A auto-ranging
- Long battery life
- Safety Standard IEC 61010-1 CAT IV 300V / CAT III 600V



	2117R
AC A	60.00/600.0/1000A (Auto-ranging) ±1.5%rdg±4dgt [45 - 65Hz] ±2.0%rdg±5dgt [40 - 1kHz]
AC V	60.00/600.0V (Auto-ranging) ±1.0%rdg±2dgt [45 - 65Hz] (600V) ±1.5%rdg±4dgt [40 - 1kHz] (60/600V)
DC V	60.00/600.0V (Auto-ranging) ±1.0%rdg±3dgt (60V) ±1.2%rdg±3dgt (600V)
Ω	600.0Ω/6.000/60.00/600.0kΩ (Auto-ranging) ±1.0%rdg±5dgt (600Ω) ±2.0%rdg±3dgt (6/60/600kΩ)
Continuity buzzer	600Ω (Buzzer sounds below 90Ω)
Conductor size	φ33mm max.
Applicable Standards	IEC 61010-1 CAT IV 300V, CAT III 600V Pollution degree 2 IEC 61010-031, IEC 61010-2-032, IEC 61010-2-033, IEC 61326-2-2(EMC), IEC 60529 IP40
Power source	R03/LR03(AAA)(1.5V)×2 *Continuous measuring time : approx. 170 hours (When R03 is used)(NCV_LED:off)(Auto power save : approx.10 minutes)
Dimensions	204(L) × 81(W) × 36(D)mm
Weight	220g Approx. (including batteries)
Accessories	7066A (Test leads), 9079 (Carrying case), R03(AAA) × 2, Instruction manual



## KEW 2127R

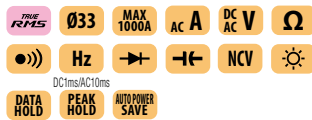

- Fully Safety jaw
- Ergonomic over-molded body gives convenient one-hand operation
- Large easy-to-read display with 0.01A resolution
- Accurate reading with True RMS 60/600/1000A auto-ranging
- Peak Hold for inrush current
- Large display with back light
- Capacitance and Diodo test
- Long battery life
- Safety standard IEC 61010-1, CAT IV 300V / CAT III 600V

	2127R
AC A	60.00/600.0/1000A (Auto-ranging) ±1.5%rdg±4dgt [45 - 65Hz] ±2.0%rdg±5dgt [40 - 1kHz]
AC V	60.00/600.0V (Auto-ranging) ±1.0%rdg±2dgt [45 - 65Hz] (600V) ±1.5%rdg±4dgt [40 - 1kHz] (60/600V)
DC V	60.00/600.0V (Auto-ranging) ±1.0%rdg±3dgt (60V) ±1.2%rdg±3dgt (600V)
Ω	600.0Ω/6.000/60.00/600.0kΩ/6.000/40.00MΩ(Auto-ranging) ±1.0%rdg±5dgt (600Ω) ±2.0%rdg±3dgt (6/60/600kΩ) ±3.0%rdg±3dgt (6MΩ) ±5.0%rdg±3dgt (40MΩ)
Continuity buzzer	600Ω (Buzzer sounds below 90Ω)
Capacitance test	1.000/10.00/100.0μF ±3.0%rdg±15dgt (1μF) ±3.0%rdg±10dgt (10/100μF)
Hz	999.9Hz/9.999kHz (Auto-ranging) ±0.1%rdg±3dgt (Input sensitivity Current:more than 4A Voltage:more than 2V)
Conductor size	φ33mm max.
Applicable Standards	IEC 61010-1 CAT IV 300V, CAT III 600V Pollution degree 2 IEC 61010-031, IEC 61010-2-032, IEC 61010-2-033, IEC 61326-2-2(EMC), IEC 60529 IP40
Power source	R03/LR03(AAA)(1.5V) × 2 *Continuous measuring time : approx. 170 hours (when R03 is used)(NCV_LED, Backlight:off)(Auto power save : approx.10 minutes)
Dimensions	204(L) × 81(W) × 36(D)mm
Weight	230g Approx. (including batteries)
Accessories	7066A (Test leads), 9079 (Carrying case), R03(AAA) × 2, Instruction manual



## KEW 2200/2200R

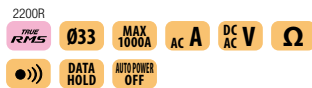

- Ultra Slim and lightweight Handy design
- φ33mm Tear Drop Jaw easy to use in tight places.
- 1000A AC Clamp Meter
- DMM function ACV, DCV, Ω, Continuity Buzzer.
- Fuseless electronic protection on Ω(→) up to 600V
- DMM function ACV, DCV, Ω, Continuity Buzzer.
- Safety Standard IEC 61010-1, 61010-2-032 CAT IV 300V\* / CAT III 600V \*2200R only
- Minimum resolution 0.01A

	2200	2200R
Detection method	Averaging value	True RMS value
AC A	40.00/400.0/1000A (Auto-ranging) ±1.4%rdg±6dgt(50/60Hz) ±1.6%rdg±6dgt(45 - 65Hz)	40.00/400.0/1000A (Auto-ranging) ±1.5%rdg±5dgt(45 - 65Hz) ±2.0%rdg±5dgt(40Hz - 1kHz)
AC V	4.000/40.00/400.0/600V (Auto-ranging) ±1.8%rdg±7dgt(45 - 65Hz) ±2.3%rdg±8dgt(65 - 500Hz)	
DC V	400.0mV/4.000/40.00/400.0/600V (Auto-ranging) ±1.0%rdg±3dgt* *400mV range is excluded	
Ω	400.0Ω/4.000/40.00/400.0kΩ/4.000/40.00MΩ (Auto-ranging) ±2.0%rdg±4dgt(0 - 400kΩ) ±4.0%rdg±4dgt(4MΩ) ±8.0%rdg±4dgt(40MΩ)	
Continuity buzzer	buzzer sounds below 50±30Ω	
Conductor size	φ33mm max.	
Applicable Standards	IEC 61010-1 CAT IV 300V*, CAT III 600V Pollution degree2(AC/A) *2200R only CAT III 300V, CAT II 600V Pollution degree2(AC/DC V) IEC 61010-031, IEC 61010-2-032, IEC 61326(EMC)	
Power source	R03/LR03(AAA)(1.5V) × 2	
Continuous measuring time	Approx.350 hours	Approx.120 hours
Auto power off	Auto power off : approx.10 minutes	
Dimensions	190(L) × 68(W) × 20(D)mm	
Weight	Approx.120g(including batteries)	
Accessories	7107A (Test leads), 9160 (Carrying case), R03(AAA) × 2, Instruction manual	



photo : 2200R

# DIGITAL CLAMP METERS AC

## KEW 2204R

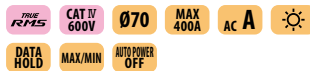

DATA HOLD MAX/MIN AUTO POWER OFF



- Flexible and light weight clamp sensor
- True RMS
- MIN / MAX function
- Backlight LCD display
- IEC 61010-1 (CAT IV 600V / CAT III 1000V)
- Minimum resolution 0.001A

		2204R
AC A (RMS)		
Range		4.000/40.00/400.0A
Accuracy		±3%rdg±5dgt(45-500Hz) (At the center of the circle formed by the flexible sensor)
Crest factor		Full scale CF<1.6, half scale<3.2 Effective input crest values are √2 times of the max values of each range.
Conductor size		φ70mm max.
Influence of Conductor position		Additional ±2%(max.) depending on the distance from the center position
Overload protection		500A AC for 10 seconds
Applicable Standards		IEC 61010-1, IEC 61010-2-032 CAT IV 600V / CAT III 1000V Pollution degree 2 IEC 61326-1(EMC), IEC 60529 IP40
Operating temperature & humidity		0 - +50°C, less than 80% RH (without condensation)
Storage temperature & humidity		-10 - +60°C, less than 70% RH (without condensation)
Power source		R03 / LR03(AAA)(1.5V) × 2 *Continuous measuring time : approx. 120 hours (Auto power off : approx.15 minutes)
Dimensions		120(L) × 70(W) × 26(D) mm : Display unit 1.8m : Sensor cable
Weight		200g Approx. (including batteries)
Accessories		9174 (Carrying case), LR03(AAA) × 2, Instruction manual

## KEW 2210R

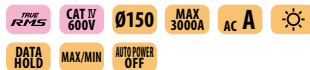

DATA HOLD MAX/MIN AUTO POWER OFF



- Flexible and light weight clamp sensor
- Wide reading range up to 3000A
- True RMS
- MIN / MAX function
- Backlight LCD display
- IEC 61010-1 (CAT IV 600V / CAT III 1000V)
- Minimum resolution 0.01A

		2210R
AC A (RMS)		
Range		30.00/300.0/3000A
Accuracy		±3%rdg±5dgt [45 - 500Hz] (At the center of the circle formed by the flexible sensor)
Crest factor		Full scale CF<1.6, half scale<3.2 Effective input crest values are √2 times of the max values of each range.
Conductor size		φ150mm max.
Influence of Conductor position		Additional ±3% (max.) depending on the distance from the center position
Overload protection		5000A AC for 10 seconds
Applicable Standards		IEC 61010-1, IEC 61010-2-030 CAT IV 600V / CAT III 1000V Pollution degree 2 IEC 61010-2-032, IEC 61326-1 (EMC), IEC 60529 IP40
Operating temperature & humidity		0 - +50°C, less than 80% RH (without condensation)
Storage temperature & humidity		-10 - +60°C, less than 70% RH (without condensation)
Power source		R03 / LR03 (AAA) (1.5V) × 2 *Continuous measuring time : approx. 120hours (Auto power off : approx. 15 minutes)
Dimensions		120 (L) × 70 (W) × 26 (D) mm : Display unit 1.8m : Sensor cable
Weight		Approx. 300g (including batteries)
Accessories		9174 (Carrying case), LR03 (AAA) × 2, Instruction manual



Easy to use in crowded cable areas



Easy to clamp a wire in hard-to-reach narrow spaces



Easy to read backlight LCD display

# DIGITAL CLAMP METERS AC/DC



CE

## KEW 2003A

CAT IV 600V Ø55 MAX 2000A DC AC A DC AC V Ω  
400ms  
DATA HOLD PEAK HOLD OUT PUT AUTO POWER SAVE

- Equipped to measure both AC and DC current with transformer jaws of large diameter.
- Can measure AC and DC currents up to 2000A.
- Output terminal for connection to recorders.
- AC/DC voltage, resistance measurement and continuity functions also available.
- Minimum resolution 0.1A

	2003A
AC A	400A/2000A(0 - 1000A) ±1.5%rdg±2dgt[50/60Hz] ±3%rdg±4dgt[40 - 500Hz] ±5%rdg±4dgt[500Hz - 1kHz] 2000A(1001 - 2000A) ±3%rdg±2dgt[50/60Hz]
DC A	400/2000A ±1.5%rdg±2dgt
AC V	400/750V ±1.5%rdg±2dgt[50/60Hz] ±1.5%rdg±4dgt[40Hz - 1kHz]
DC V	400/1000V ±1%rdg±2dgt
Ω	400/4000Ω ±1.5%rdg±2dgt
Continuity buzzer	buzzer sounds below 50±35Ω
Conductor size	φ55mm max.
Frequency response	40Hz - 1kHz
Output	Recorder: DC400mV against AC/DC400A DC200mV against AC/DC2000A
Applicable Standards	IEC 61010-1 CAT IV 600V, CAT III 1000V IEC 61010-2-032
Power source	R6(AA)(1.5V) × 2 *Continuous measuring time : approx. 100 hours(Auto power save : approx. 10 minutes)
Dimensions	250(L) × 105(W) × 49(D)mm
Weight	530g approx.
Accessories	7107A(Test leads) 9094(Carrying case) R6(AA) × 2 Instruction manual
Optional	7256(Output cord)



CE

## KEW 2009R

TRUE RMS CAT IV 600V Ø55 MAX 2000A DC AC A DC AC V  
10ms  
Ω Hz DATA HOLD PEAK HOLD OUT PUT  
AUTO POWER OFF

- True RMS reading instrument ideal for accurate measurement of distorted waveforms and non-sinusoidal waveforms arising from thyristors.
- Can measure AC and DC currents up to 2000A.
- Output terminal for connection to recorders.
- Minimum resolution 0.1A

	2009R
AC A	400.0/2000A ±1.3%rdg±3dgt (0 - 400A,150 - 1700A)(45 - 66Hz) ±2.0%rdg±5dgt (0 - 400A,150 - 1700A)(20Hz - 1kHz) ±2.3%rdg±3dgt (1701 - 2000A)(45 - 66Hz)
DC A	400.0/2000A ±1.3%rdg±2dgt
AC V	40.00/400.0/750V ±1.0%rdg±3dgt (45 - 66Hz) ±1.5%rdg±5dgt (20Hz - 1kHz)
DC V	40.00/400.0/1000V ±1.0%rdg±2dgt
Ω	400.0/4000Ω ±1.5%rdg±2dgt
Continuity buzzer	Buzzer sounds below 20Ω
Hz	10 - 4000Hz ±1.5%rdg±5dgt (Input sensitivity Current:more than 40A Voltage:more than 10V)
Output	Recorder: DC400mV against AC/DC400A DC200mV against AC/DC2000A
Conductor size	φ55mm max.
Applicable Standards	IEC 61010-1 CAT IV 600V, CAT III 1000V IEC 61010-2-032, IEC 61326-1, IEC 61326-2-1
Power source	R6 (1.5V) × 2 *Continuous measuring time: approx. 15 hours (Auto power off: approx. 10 minutes)
Dimensions	250 (L) × 105 (W) × 49 (D) mm
Weight	Approx. 540g(including batteries)
Accessories	7107A(Test leads) 9094(Carrying case) R6(AA)(1.5V) × 2, Instruction manual
Optional	7256(Output cord)



## MODEL 2010

Ø7.5 MAX 20A DC AC A OUT PUT

- High sensitivity, miniature AC/DC clamp meter.
- 0.1mA minimum resolution for AC current and 1mA minimum resolution for DC current.
- Output terminal for recorder connection.

	2010
AC A	200mA/2/20A ±1%rdg±2dgt[50/60Hz](200mA) ±1.5%rdg±8dgt[40Hz - 2kHz](200mA) ±1%rdg±2dgt[50/60Hz](2A) ±2.5%rdg±10dgt[40Hz - 2kHz](2/20A)
DC A	2/20A ±1%rdg±2dgt(2A) ±1.5%rdg±4dgt(20A)
Conductor size	φ7.5mm max.
Frequency response	DC 40Hz - 2kHz
Output	Recorder: DC200mV against AC200mA/2/20A DC200mV against DC2/20A
Power source	6LR61(9V Alkaline battery) × 1 or AC adaptor *Continuous measuring time : approx. 20 hours (DC)/approx. 40 hours (AC)
Dimensions	142(L) × 64(W) × 26(D)mm : Display unit 153(L) × 23(W) × 18(D)mm : Sensor
Weight	220g approx.
Accessories	9095(Carrying Case) 6LR61 × 1 Instruction manual
Optional	7256(Output cord)

# DIGITAL CLAMP METERS AC/DC



CE

## MODEL 2033

Ø24 MAX 300A DC AC A DATA HOLD AUTO POWER SAVE

- Smallest clamp meter capable of AC and DC current measurements.
- 300A auto ranging has minimum resolution of 0.01A AC/DC.
- Auto-zero function to allow one touch zero adjustment.

	2033
AC A	40/300A ±1%rdg±4dgt[50/60Hz](0 - 40A) ±2.5%rdg±4dgt[20Hz - 1kHz](0 - 40A) ±1.5%rdg±4dgt[50/60Hz](20 - 200A) ±2.5%rdg±4dgt[20Hz - 1kHz](20 - 200A) ±3.5%rdg[50/60Hz](200 - 300A) ±4%rdg[20Hz - 1kHz](200 - 300A)
DC A	40/300A ±1%rdg±4dgt(0 - ±40A) ±1.5%rdg±4dgt(±20 - ±200A) ±3%rdg(±200 - ±300A)
Conductor size	φ24mm max.
Frequency response	DC 20Hz - 1kHz
Applicable Standards	IEC 61010-1 CAT III 300V IEC 61010-2-032
Power source	LR-44(1.5V) × 2 *Continuous measuring time : approx. 10 hours (Auto power save : approx. 5 minutes)
Dimensions	147(L) × 59(W) × 25(D)mm
Weight	100g approx.
Accessories	9090 (Carrying case) LR-44 × 2 Instruction manual

CE



## KEW 2046R

RMS CAT IV 600V Ø33 MAX 600A DC AC V DC AC A  
Ω Hz DUTY 10ms  
°C NCV DATA HOLD PEAK HOLD MAX/MIN  
REL AUTO POWER OFF

- Very useful for power distribution companies, power utilities and maintenance fields.
- Red LED, as "Non Contact Voltage" function, gives warning to the user on the presence of AC voltage.
- Double molding gives comfortable feeling in palm.
- 6039 counts with Bar Graph display.
- Minimum resolution 0.1A

	2046R
AC A	0 - 600.0A ±2.0%rdg±5dgt(50/60Hz) ±3.5%rdg±5dgt(40 - 500Hz)
DC A	0 - 600.0A ±1.5%rdg±5dgt
AC V	6/60/600V(Auto Ranging) ±1.5%rdg±4dgt(50/60Hz) ±3.5%rdg±5dgt(40 - 400Hz)
DC V	600m/6/60/600V(Auto Ranging) ±1.0%rdg±3dgt
Ω	600/6k/60k/600k/6M/60MΩ(Auto Ranging) ±1%rdg±5dgt(600 - 6M) / ±5%rdg±8dgt(60M)
Continuity buzzer	Buzzer Sounds at 100Ω
Hz	10/100/1k/10kHz(Auto Ranging) (Input sensitivity Current:more than 50A[40 - 400Hz] Voltage:more than 1V[6V Range], 4.2V[60V Range], 42V[600V Range][ - 10kHz])
DUTY	0.1 - 99.9% ±2.5%rdg ±5dgt (Pulse width/Pulse cycle)
Capacitance test	400n/4μ/40μF(Auto Ranging)
Temperature	-50°C - +300°C(with the use of Temperature probe 8216)
Conductor size	φ33
Applicable Standards	IEC 61010-1 CAT IV 600V IEC 61010-2-032, IEC 61326
Power source	R03 (1.5V)(AAA) × 2 *Continuous measuring time : approx. 10 hours (Auto power off : approx. 15 minutes)
Dimensions	243(L) × 77(W) × 36(D) mm
Weight	300g approx.
Accessories	7066A(Test leads) 9094(Carrying case) R03 × 2 Instruction manual
Optional	8216(Temperature probe)

CE



## KEW 2055/2056R

2056R RMS CAT IV 600V Ø40 MAX 1000A DC AC V DC AC A 2056R  
Ω Hz DUTY 10ms  
°C NCV DATA HOLD PEAK HOLD MAX/MIN  
REL 2055 AUTO POWER SAVE 2056R AUTO POWER OFF

- Very useful for power distribution companies, power utilities and maintenance fields.
- Red LED, as "Non Contact Voltage" function, gives warning to the user on the presence of AC voltage.
- Double molding gives comfortable feeling in palm.
- 6039 counts with Bar Graph display.
- Minimum resolution 0.1A

	2055	2056R
AC A	0 - 600.0/1000A ±1.5%rdg±5dgt(50/60Hz) ±3.0%rdg±5dgt(40 - 400Hz)	0 - 600.0/1000A ±2.0%rdg±5dgt(50/60Hz) ±3.5%rdg±5dgt(40 - 500Hz)
DC A	0 - 600.0/1000A ±1.5%rdg±5dgt	
AC V	6/60/600V(Auto Ranging) ±1.3%rdg±4dgt(50/60Hz) ±3.0%rdg±5dgt(40 - 400Hz)	6/60/600V(Auto Ranging) ±1.5%rdg±4dgt(50/60Hz) ±3.5%rdg±5dgt(40 - 400Hz)
DC V	600m/6/60/600V(Auto Ranging) ±1.0%rdg±3dgt	
Ω	600/6k/60k/600k/6M/60MΩ (Auto Ranging) ±1%rdg±5dgt(600 - 6M) / ±5%rdg±8dgt(60M)	
Continuity buzzer	Buzzer Sounds at 100Ω	
Capacitance test	-	400n/4μ/40μF(Auto Ranging)
Temperature	-	-50°C - +300°C (with the use of Temperature probe 8216)
Hz	10/100/1k/10kHz(Auto Ranging) (Input sensitivity Current:more than 50A[40 - 400Hz] Voltage:more than 1V[6V Range], 4.2V[60V Range], 42V[600V Range][ - 10kHz])	
DUTY	0.1 - 99.9% ±2.5%rdg ±5dgt (Pulse width/Pulse cycle)	
Conductor size	φ40	
Applicable Standards	IEC 61010-1 CAT IV 600V, IEC 61010-2-032, IEC 61326	
Power source	R03 (1.5V)(AAA) × 2 *Continuous measuring time : approx. 35 hours (Auto power save : approx. 15 minutes) (2055) *Continuous measuring time : approx. 10 hours (Auto power off : approx. 15 minutes) (2056R)	
Dimensions	254(L) × 82(W) × 36(D) mm	
Weight	310g approx.	
Accessories	7066A(Test leads) 9094(Carrying case) R03 × 2 Instruction manual	
Optional	-	8216(Temperature probe)

photo : 2056R



# DC MILLIAMP CLAMP METER/CLAMP LOGGER

## KEW 2500/2510

2510 2510  
 Ø6 DC A DATA HOLD AUTO POWER OFF OUT PUT Bluetooth External Power Supply



photo : 2510

	2500	2510
DC A	20/100mA(Auto ranging) ±0.2%rdg±5dgt(0.00mA - 21.49mA) ±1.0%rdg±5dgt(21.0mA - 120.0mA)	
Conductor size	φ6mm max.	
Analog output	Recorder: DC1000mV against DC100mA	
Communication Interface	-	Bluetooth® Ver2.1+EDR Class2 *
Applicable Standards	IEC 61010-1, Pollution degree 2 IEC 61010-2-032, IEC 61326-1(EMC) IEC 60529 IP40	
Operating temperature & humidity	-10 - +50°C < 85%	
Storage temperature & humidity	-20 - +60°C < 85%	
Power source	R6/LR6(AA) (1.5V) × 4	R6/LR6(AA) (1.5V) × 4 (Alkaline LR6 is recommended.) External supply (AC adapter MODEL8320)
Battery life	Approx. 60 hours continuous (with Backlight and LED light OFF)	Approx. 50 hours continuous with alkaline batteries (with Backlight, LED light and Bluetooth® feature OFF)
Dimensions	111(L) × 61(W) × 40(D)mm : Display unit 104(L) × 34(W) × 20(D)mm : Sensor 700mm : Sensor cable	111(L) × 61(W) × 46(D)mm : Display unit 104(L) × 34(W) × 20(D)mm : Sensor 700mm : Sensor cable
Weight	Approx. 290g (including batteries)	
Accessories	9096(Carrying case) LR6(AA) × 4 Instruction manual	8320(AC adapter) KEW Windows for 2510(Software) 9096(Carrying case) LR6(AA) × 4, Instruction manual Software installation manual
Optional	7256(Output cord)	

\*Some countries regulate the compliance with their Radio Law of the products equipped with Bluetooth®. Please confirm it with your distributor before purchasing our products equipped with Bluetooth®.



- 0.01mA resolution for DC current
- Top class measurement 0.2% accuracy
- Ø6mm clamp jaw easy to use in tight places
- Measurement from 0.01mA to 120.0mA
- Dual display with backlight shows both mA measurement and percent of 4-20 mA span
- Spotlight for illuminating measurement point
- Analog output terminal for recorder connection
- Memory function stores up to 192,000 records (2510 only).
- Transfer data to PC via Bluetooth (2510 only).

### Analog output terminal for recorder connection

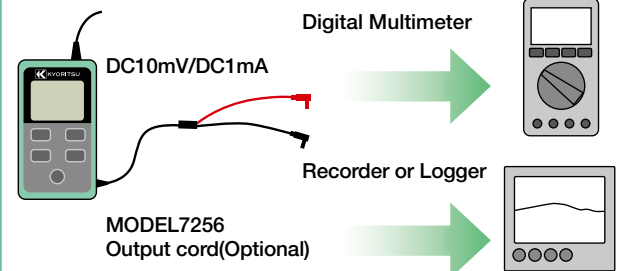

Note: The Auto-power OFF can be disabled for long recording

### Memory function/Communication function (2510 Only)

Measured data can be transferred to a PC

Five selectable recording intervals

Memory capacity up to 192,000 data

Analyzing and processing the measured data with a PC

Recording interval	Max recording period
1 sec	53 hours
5 sec	11 days
10 sec	22 days
30 sec	66 days
60 sec	133 days

External supply

Bluetooth®

OS : Windows® 11/10/8.1  
 Display : XGA(Resolution 1024 × 768 dots) or more  
 HDD : Space required 1Gbyte or more  
 Other : With CD-ROM drive , NET Framework (3.5 or more)

\* Windows® is registered trademark of Microsoft in the United States.  
 \* Bluetooth® is a registered trademark of Bluetooth SIG.

### Accessories

MODEL 9096 Carrying case

2510 only

MODEL 8320 AC adapter

Optional Accessory

MODEL 7256 Output cord

KEW windows for 2510

### Diameter of measurable conductor : φ6mm max



### Applicable to signal measurement on process and building instrumentation



### Spotlight LED & Backlight Display



# LEAKAGE CLAMP METERS



CE

## MODEL 2431

Ø24 MAX 200A Resolution 0.01mA AC A DATA HOLD Filter

AUTO POWER OFF

- Frequency Selector Switch to eliminate the effect of harmonics.
- Auto power-off function
- Rotary switch for easy one finger power-on and range selection.
- Minimum resolution 0.01mA

	2431
AC A (50/60Hz)	20/200mA/200A ±3%rdg±5dgt(20/200mA/100A) ±5%rdg±5dgt(200A)
AC A (WIDE)	20/200mA/200A ±2%rdg±4dgt[50/60Hz](20/200mA/0 - 100A) ±5%rdg±6dgt[40 - 400Hz](20/200mA/0 - 100A) ±5%rdg±4dgt[50/60Hz](100.1 - 200A)
Conductor size	φ24mm max.
Frequency response	40 - 400Hz
Effect of external stray magnetic field φ15mm 100A	10mA AC max.
Applicable Standards	IEC 61010-1 CAT III 300V IEC 61010-2-032
Power source	LR-44(1.5V) × 2 *Continuous measuring time : approx. 15 hours (Auto power off : approx. 10 minutes)
Dimensions	149(L) × 60(W) × 26(D)mm
Weight	120g approx.
Accessories	9090 (Carrying case) LR-44 × 2 Instruction manual



CE

## MODEL 2432

High Sensitive Model

Ø40 MAX 100A Resolution 0.001mA AC A DATA HOLD PEAK HOLD

10ms

Filter

AUTO POWER OFF

- Frequency Selector Switch to eliminate the effect of harmonics.
- Three ranges: 4mA/40mA/100A.
- Minimum resolution 0.001mA

	2432
AC A (50/60Hz)	4/40mA/100A ±1%rdg±5dgt(4/40mA) ±1%rdg±5dgt(0 - 80A) ±5%rdg(80.1 - 100A)
AC A (WIDE)	4/40mA/100A ±1%rdg±5dgt[50/60Hz] ±2.5%rdg±10dgt[20Hz - 1kHz](4/40mA) ±1%rdg±5dgt[50/60Hz] ±2.5%rdg±10dgt[40Hz - 1kHz](0 - 80A) ±5%rdg[50/60Hz] ±10%rdg[40Hz - 1kHz](80.1 - 100A)
Maximum circuit voltage	600V AC/DC (between line/neutral) 300V AC/DC (against earth)
Conductor size	φ40mm max.
Frequency response	20Hz - 1kHz(40Hz - 1kHz:100A)
Effect of external stray magnetic field	2mA AC approx. in proximity to a 15mm-dia conductor carrying 100A AC
Applicable Standards	IEC 61010-1 CAT III 300V Pollution degree 2 IEC 61010-2-032
Power source	R03(DC1.5V) × 2 *Continuous measuring time : approx. 40 hours (Auto power off : approx. 10 minutes)
Dimensions	185(L) × 81(W) × 32(D)mm
Weight	290g approx.
Accessories	9097(Carrying case) R03(1.5V) × 2 Instruction manual



CE

## MODEL 2433/2433R

2433R TRUE RMS Ø40 MAX 400A Resolution 0.01mA AC A DATA HOLD

10ms

PEAK HOLD Filter

AUTO POWER OFF

- Frequency Selector Switch to eliminate the effect of harmonics.
- Three ranges: 40mA/400mA/400A.
- Minimum resolution 0.01mA

	2433	2433R
AC A (50/60Hz)	40.00/400.0mA/400.0A ±1%rdg±5dgt(40/400mA) ±1%rdg±5dgt(0 - 350A) ±2%rdg(350.1 - 399.9A)	40.00/400.0mA/400.0A ±1%rdg±5dgt(0 - 100A) ±1%rdg±5dgt(100 - 300A) ±2%rdg(300 - 400A)
AC A (WIDE)	40.00/400.0mA/400.0A ±2.5%rdg±10dgt[20Hz - 1kHz](40/400mA) ±2.5%rdg±10dgt[40Hz - 1kHz](0 - 350A) ±5%rdg[40Hz - 1kHz](350.1 - 399.9A)	40.00/400.0mA/400.0A ±2.5%rdg±10dgt[20Hz - 1kHz](0/100A) ±2.5%rdg±10dgt[40Hz - 1kHz](100 - 300A) ±5%rdg[40Hz - 1kHz](300 - 400A)
Maximum circuit voltage	600V AC/DC (between line/neutral)	300V AC/DC (against earth)
Conductor size	φ40mm max.	
Frequency response	20Hz - 1kHz(40Hz - 1kHz:400A)	
Effect of external stray magnetic field	10mA AC approx. in proximity to a 15mm-dia conductor carrying 100A AC	
Applicable Standards	IEC 61010-1 CAT III 300V Pollution degree 2	IEC 61010-2-032
Power source	R03 (DC1.5V) × 2 *Continuous measuring time : approx. 40 hours (2433) *Continuous measuring time : approx. 24 hours (2433R) (Auto power off : approx 10 minutes)	
Dimensions	185(L) × 81(W) × 32(D)mm	
Weight	270g approx.	
Accessories	9097 (Carrying case) R03(1.5V) × 2	Instruction manual

photo : 2433R

# LEAKAGE CLAMP METERS/FORK CURRENT TESTER

## KEW 2413F/2413R



2413R  
 True RMS Ø68 MAX 1000A AC A DATA HOLD PEAK HOLD  
 Resolution 0.1mA OUT PUT Filter

- Large transformer jaws of 68mm diameter makes it possible to clamp on all three or four wires (3 phases) together for leakage current measurement.
- Frequency filter switch to eliminate the effect of the harmonics.
- 2 way analogue output terminal.
- Minimum resolution 0.1mA

photo : 2413R

	2413F	2413R
AC A (50/60Hz)	200mA/2/20/200A/1000A ±1.5%rdg±2dgt(200mA/2/20A) ±2.0%rdg±2dgt(200A/0 - 500A) ±5.5%rdg(501 - 1000A)	200mA/2/20/200/1000A ±2.5%rdg±5dgt(200mA/2/20A) ±3.0%rdg±5dgt(200A/0 - 500A) ±5.5%rdg(501 - 1000A)
AC A (WIDE)	200mA/2/20/200A/1000A ±1.0%rdg±2dgt[50/60Hz] ±3.0%rdg±2dgt[40Hz - 1kHz](200mA/2/20A) ±1.5%rdg±2dgt[50/60Hz] ±3.5%rdg±2dgt[40Hz - 1kHz](200A/0 - 500A) ±5%rdg[50/60Hz] ±10%rdg[40Hz - 1kHz](501 - 1000A)	200mA/2/20/200/1000A ±1.8%rdg±5dgt[50/60Hz] ±3.0%rdg±5dgt[40Hz - 1kHz](200mA/2/20A) ±2.0%rdg±5dgt[50/60Hz] ±3.5%rdg±5dgt[40Hz - 1kHz](200A/0 - 500A) ±5.0%rdg[50/60Hz](501 - 1000A)
Conductor size	φ68mm max.	
Frequency response	40Hz - 1kHz	
Effect of external stray magnetic field φ15mm 100A	10mA AC max.	
Output	Waveform:AC200mV against the maximum value of each range (1000A range is 100mV) Recorder:DC200mV against the maximum value of each range (1000A range is 100mV)	
Crest factor	—	3.0 or Less
Applicable Standards	IEC 61010-1 CAT III 300V IEC 61010-2-032	
Power source	6F22(9V) × 1 *Continuous measuring time : approx. 60 hours	
Dimensions	250(L) × 130(W) × 50(D)mm	
Weight	570g approx.	600g approx.
Accessories	9094(Carrying case) 6F22 × 1	Instruction manual
Optional	7073(2WAY Output cord)	

CE

## MODEL 2434



Ø28 MAX 100A Resolution 0.1mA AC A DATA HOLD Filter  
 AUTO POWER SAVE

- Least affected by external stray magnetic field.
- 20mA AC max. in proximity to a 15mm-dia conductor carrying 100A AC.
- Frequency Selector Switch to eliminate the effect of harmonics.
- Minimum resolution 0.1mA

	2434
AC A (50/60Hz)	400mA/4/100A ±2%rdg±4dgt
AC A (WIDE)	400mA/4/100A ±2%rdg±4dgt[50/60Hz] ±3%rdg±5dgt[40 - 400Hz]
Conductor size	φ28mm max.
Frequency response	40 - 400Hz
Effect of external stray magnetic field φ15mm 100A	20mA AC max.
Applicable Standards	IEC 61010-1 CAT III 300V IEC 61010-2-032
Power source	R03(AAA) (1.5V) × 2 *Continuous measuring time : approx. 150 hours(Auto power save : approx. 10 minutes)
Dimensions	169(L) × 75(W) × 40(D)mm
Weight	220g approx.
Accessories	9097(Carrying case) R03 × 2 Instruction manual

CE

## MODEL 2300R

### KEW FORK CURRENT TESTER



True RMS Ø10 MAX 100A DC AC A NCV DATA HOLD  
 AUTO POWER OFF

- True RMS reading is an essential feature for accurate measurement.
- "Non Contact" voltage function indicates the presence of AC voltage by warning the user with an audible signal.
- Set the DC current range to zero in one touch with the Zero Adjust function.
- Auto Power Off.
- Minimum resolution 0.1A

	2300R
Current measurement	AC A 0 - 100.0A ±2.0%rdg±5dgt [50/60Hz] DC A 0 - ±100.0A ±2.0%rdg±5dgt
Crest factor	2.5
Non contact voltage	Detect AC voltage without contacting with socket wire During voltage detection, "Hi" flashes and a buzzer sounds
Maximum digit	1,049
Conductor size	Max φ10mm
Applicable Standards	IEC 61010-1 CAT III 300V Pollution degree 2
Power source	R03 (AAA) × 2 (Auto power off : approx. 10 minutes) *Continuous measuring time : AC A approx. 46 hours DC A approx. 52 hours
Dimensions	161.3(L) × 40.2(W) × 30.3(D)mm
Weight	110g (including batteries)
Accessories	9113(Carrying case) R03 (AAA) × 2 Instruction manual



KEW FORK 2300R can be used in crowded connection boxes, where cables are very short, and space is too limited to clamp cables using with a traditional clamp meter.

CE

LEAKAGE CLAMP METERS/FORK CURRENT TESTER

# LEAKAGE CLAMP METERS

## ADVANTAGES USING THE KYORITSU LEAKAGE CLAMP METERS:

- Work professionally: No need random check to identify the fault that causes RCD tripping. In fact our leakage clamp meters measure exactly the same leakage current to earth / ground detected by RCD. Once you measured it, you trace and find it. It is like to have an RCD "built-in" your clamp meter, nothing will trip on it but you will measure the leakage current on its display!
- Easy to use, you just need to clamp:
  - all active conductors (for leakage current measurements)
  - or just one phase (for the AC load current measurements, like the conventional clamp meters ranging up to 100A / 200A / 400A or 1000A, depends on the model).
- Before starting any action, clamping the active conductors at the origin of the electrical installation: you will immediately know if there is a leakage current to earth / ground.
- Then you will trace the leakage current clamping every secondary circuit one by one and without disconnecting the conductors in the junction boxes (see the below example).
- No wasting time because using these special clamp meters you will find out the fault without turning OFF the power line.
- When there are more than one fault, that only the sum of them causes the RCD tripping, such clamp meters are even more useful for a definitive solution.
- An essential tool to identify the causes of leakage current to earth / ground, you will appreciate it since the first use!

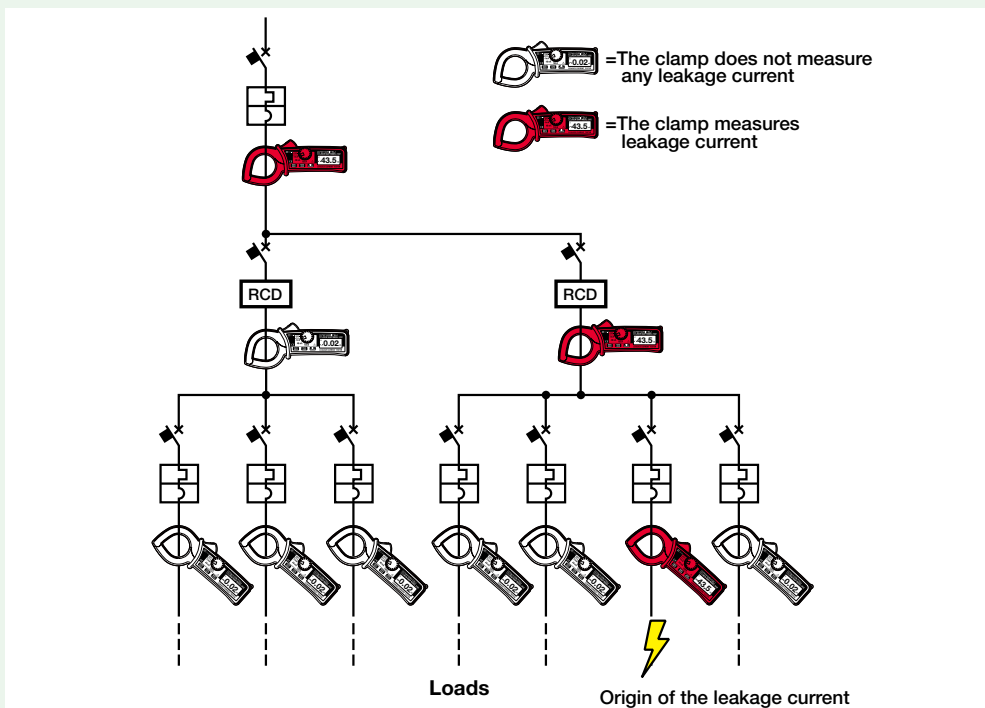

## High frequency selector switch

All the leakage clamp meters of Kyoritsu have a frequency response selector switch that allows you to determine the level of earth / ground leakage current including or not the high frequency. In other words, it can help to identify the "traditional" leakage current at 50/60 Hz (generated by low insulation condition of motors, of old lightings, of cables, etc) and the "high frequency" leakage current (generated by PC, inverters, UPS, harmonics, etc). Therefore this feature is very helpful for a quick judgment: the leakage is due to poor insulation resistance or due to problems with devices that work with high frequency.

Discover here more details on the use of the Kyoritsu Leakage clamp meters: <https://www.kew-ltd.co.jp/en/support/applicationnotes.html>

# CLAMP SENSOR/CLAMP ADAPTOR

## KEW 8115

### CLAMP SENSOR

Ø12 AC MAX 130A DC MAX 180A DC AC A AUTO POWER OFF



CE

- Permits extension of the AC and DC current ranges of almost any Digital Multimeters (DMMs) without breaking the circuit under test.
- Using KEW 8115 with KEW 1051/1052 (DMM) the display can be set for direct reading in A.

	8115	
Measuring range	AC 0.1 - 130Arms	DC 0 - ±180A
Output voltage	AC 10mV/A	DC 10mV/A
Accuracy	±1.2%rdg±0.4mV (50/60Hz) ±2.5%rdg±0.4mV (40Hz - 1kHz)	±1.2%rdg±0.4mV (*)
Low battery warning	2.2V±0.2V or less - Red LED flash (1.9V±0.2V - Automatically power off)	
Conductor size	φ12mm max.	
Operating temperature & humidity range	-10 - 55°C, relative humidity 85% or less (no condensation)	
Output impedance	Approx. 10Ω or less	
Applicable Standards	IEC 61010-1 CAT III 300V Pollution degree 2, IEC 61010-2-032, IEC 61326-1	
Power source	LR03(AAA)(1.5V) × 2 Continuous use: approx. 40 hours(Auto power off: approx. 20 minutes)	
Cord length	Approx. 1,200mm	
Output connector	φ4mm banana plug	
Dimensions	127(L) × 42(W) × 22(D) mm	
Weight	Approx. 140g	
Accessories	9095(Carrying case), LR03(AAA) × 2, Instruction manual	

\*This accuracy is defined after the completion of the KEW 8115 zero-adjustment whilst connected to a DMM.

## MODEL 8112

### CLAMP ADAPTOR

Ø8 MAX 120A AC A



CE

Model 8112 clamp adaptor is designed to be an AC current/voltage conversion probe capable of measuring AC current from 0.1mA to 120A in conjunction with digital multimeters.

		8112		
Range	Measuring ranges	Output voltage	Accuracy	Frequency response
200mA	AC 0 - 500mA	AC1V/A	±1.5%rdg±0.2mA	50Hz - 1kHz
	AC 0 - 1000mA	(1000mA→1V)	±3%rdg±0.4mA	40Hz - 10kHz
2A	AC 0 - 20A	AC100mV/A	±1%rdg±1mA	40Hz - 1kHz
		(20A→2V)	±1.5%rdg±2mA	1k - 10kHz
20A	AC 0 - 20A	AC10mV/A (120A→1.2V)	±1%rdg±0.01A	40Hz - 1kHz
	AC 20 - 60A		±2.5%rdg	50Hz - 10kHz
	AC 60 - 120A		±2.5%rdg	100Hz - 10kHz
Conductor size	φ8mm max.			
Frequency characteristics	30Hz - 100kHz(-3dB)			
Applicable Standard	IEC 61010-1 CAT II 100V Pollution degree 2.			
Dimensions	153(L) × 18(W) × 23(D)mm			
Weight	100g approx.			
Accessories	9095(Carrying case) Instruction manual			

## KEW 8161

### CLAMP SENSOR

Ø24 MAX 100A AC A



CE

- KEW 8161 clamp sensor is designed to be an AC current / voltage conversion probe capable of measuring AC current up to 100A in conjunction with digital multimeters.

	8161
Measuring range	AC0 - 100A
Output voltage	AC 1000mV/AC 100A(10mV/A)
Accuracy	±2.0%rdg±3.0mV (45 - 65Hz) ±2.5%rdg±3.0mV (65 - 1kHz)
Conductor size	φ24mm max.
Operating temperature & humidity range	-10 - 50°C, relative humidity: 85% or less(no condensation)
Output impedance	22Ω or less
Applicable Standards	IEC 61010-1 CAT III 300V Pollution degree 2 IEC 61010-2-032, IEC 61326-1,2-2
Withstand voltage	AC3470Vrms (50/60Hz)for 5 sec.
Insulation resistance	50MΩ or greater at 1000V
Output connector	22Ω or less
Dimensions	97(L) × 59(W) × 26(D)mm
Cable length	Approx. 1.2m
Weight	270g approx.
Accessories	Instruction manual





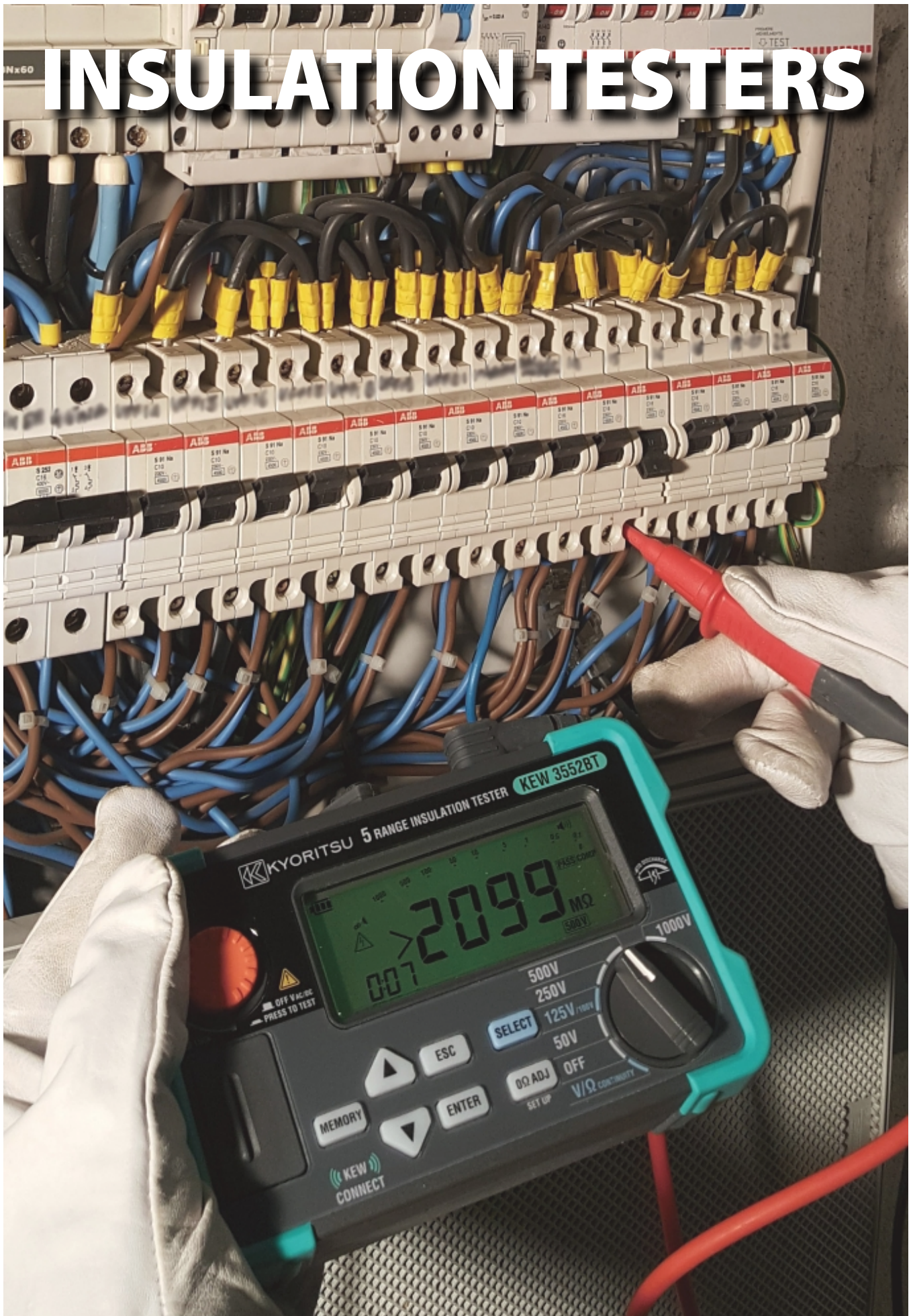



# INSULATION TESTERS











INSULATION TESTERS









# INSULATION TESTERS

## Selection Guide of Insulation Testers

	Analogue Insulation Testers				Analogue Insulation/Continuity Testers	
	3165	3166	3161A	3431	3131A	3132A
Appearance	 photo : 3165					
Test voltage	1 range		2 ranges	3 ranges		
Rated voltage (Max. measurement value)	500V(1000MΩ)	1000V(2000MΩ)	15V(20MΩ) 500V(100MΩ)	250V(200MΩ) 500V(200MΩ) 1000V(2000MΩ)	250V(100MΩ) 500V(200MΩ) 1000V(400MΩ)	250V(100MΩ) 500V(200MΩ) 1000V(400MΩ)
Continuity 	-	-	-	-	2/20Ω	3/500Ω
AC Voltage 	600V	600V	600V	600V	-	600V
DC Voltage 	-	-	-	600V	-	-
Back light 	-	-	✓	✓	✓	-
Power source	R6 × 4	R6 × 4	R6 × 4	LR6 × 4	R6 × 6	R6 × 6
Dimensions (L) × (W) × (D)mm	90 × 137 × 40	90 × 137 × 40	90 × 137 × 40	97 × 156 × 46	167 × 185 × 89	106 × 160 × 72
Weight(Approx.)	330g	330g	340g	430g	860g	560g

	Digital Insulation/Continuity Testers								
	3005A	3007A	3021A	3022A	3023A	3551	3552	3552BT	
Appearance			 photo : 3021A						
Test voltage	3 ranges		4 ranges			6 ranges			
Rated voltage (Max. measurement value)	250V(2000MΩ) 500V(2000MΩ) 1000V(2000MΩ)	250V(2000MΩ) 500V(2000MΩ) 1000V(2000MΩ)	125V(200MΩ) 250V(2000MΩ) 500V(2000MΩ) 1000V(2000MΩ)	50V(200MΩ) 100V(200MΩ) 250V(2000MΩ) 500V(2000MΩ)	100V(200MΩ) 250V(2000MΩ) 500V(2000MΩ) 1000V(2000MΩ)	50V(100MΩ) 100V(200MΩ) 125V(250MΩ) 250V(500MΩ) 500V(2000MΩ) 1000V(4000MΩ)	50V(100MΩ) 100V(200MΩ) 125V(250MΩ) 250V(500MΩ) 500V(20GΩ) 1000V(40GΩ)	50V(100MΩ) 100V(200MΩ) 125V(250MΩ) 250V(500MΩ) 500V(20GΩ) 1000V(40GΩ)	
Continuity 	20/200/2000Ω	20/200/2000Ω	40/400Ω	40/400Ω	40/400Ω	40/400/4000Ω	40/400/4000Ω	40/400/4000Ω	
Continuity buzzer 	✓	✓	✓	✓	✓	✓	✓	✓	
AC Voltage 	600V	600V	20 - 600V	20 - 600V	20 - 600V	2.0 - 600V	2.0 - 600V	2.0 - 600V	
DC Voltage 	-	-	-20 - -600V 20 - 600V	-20 - -600V 20 - 600V	-20 - -600V 20 - 600V	-2.0 - -600V 2.0 - 600V	-2.0 - -600V 2.0 - 600V	-2.0 - -600V 2.0 - 600V	
Back light 	-	✓	✓	✓	✓	✓	✓	✓	
Communication Interface	-	-	-	-	-	-	USB	USB, Bluetooth®	
Power source	R6 × 8	R6 × 8	R6 × 6	R6 × 6	R6 × 6	LR6 × 4	LR6 × 4	LR6 × 4	
Dimensions (L) × (W) × (D)mm	167 × 185 × 89	167 × 185 × 89	105 × 158 × 70	105 × 158 × 70	105 × 158 × 70	97 × 156 × 46	97 × 156 × 46	97 × 156 × 46	
Weight(Approx.)	970g	990g	600g	600g	600g	490g	490g	490g	

	Analogue High Voltage Insulation Testers			Digital High Voltage Insulation Testers		
	3121B/3122B	3123A	3124A	3025A/3125A	3127	3128
Appearance	 photo : 3121B			 photo : 3125A		
Test voltage	1 range	2 ranges	Variable	3025A: 4 ranges 3125A: 5 ranges	5 ranges	6 ranges(Variable)
Rated voltage (Max. measurement value)	3121B: 2500V(100GΩ) 3122B: 5000V(200GΩ)	5000V(200GΩ) 10000V(400GΩ)	1000V(100MΩ) 1k - 10kV(100GΩ)	250V(100MΩ) 500V(1000MΩ) 1000V(2GΩ) 2500V(100GΩ) 5000V(1000GΩ)*	250V(9.99GΩ) 500V(99.9GΩ) 1000V(199GΩ) 2500V(999GΩ) 5000V(9.99TΩ)	500V(500GΩ) 1000V(1TΩ) 2500V(2.5TΩ) 5000V(5TΩ) 10000V(35TΩ) 12000V(35TΩ)
AC/DC Voltage 	-	-	-	30 - 600V AC/DC	30 - 600V AC/DC	30 - 600V AC/DC
Current	-	-	-	-	0.00nA - 5.50mA	5.00nA - 2.40mA
Capacitance	-	-	-	-	5.0nF - 50.0μF*	5.0nF - 50.0μF*
Back light 	-	-	-	✓	✓	✓
Communication Interface	-	-	-	-	USB, Bluetooth®	USB
Power source	LR14 × 8	R6 × 8	Ni-MH rechargeable battery(1.2V) × 8	LR14 × 8	Rechargeable lead storage battery (12V)	Rechargeable lead storage battery (12V)
Dimensions (L) × (W) × (D)mm	177 × 226 × 100	200 × 140 × 80	200 × 140 × 80	177 × 226 × 100	380 × 430 × 154 (Instrument and Hard case)	330 × 410 × 180 (Instrument and Hard case)
Weight(Approx.)	3121B: 1600g 3122B: 1700g	1000g	1500g	3025A: 1700g 3125A: 1900g	8000g	9000g

\*3125A only

\*At 5000V range 5.0nF - 25.0μF

\*At 10000/12000V range 5.0nF - 1.0μF

# DIGITAL INSULATION/CONTINUITY TESTERS

## MODEL 3005A / 3007A

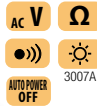

photo : 3007A

- Bar graph to display insulation resistance.
- Displays the value of external AC voltage along with flashing symbol.
- Auto null function to automatically subtract the test lead resistance before displaying the real continuity resistance value.
- Trac-Lok mode to conserve battery life on insulation and continuity tests (Model 3007A only).
- Live circuit warning beeper.
- Releasing the test button automatically discharges the charges stored in the circuit under test.
- Backlight function to view the test results in dimly lit areas (Model 3007A only).
- 200mA continuity measuring current to IEC 61557.
- Minimum 1mA current on insulation tests to IEC 61557.

3005A/3007A	
Insulation resistance	
Test voltage	250V/500V/1000V
Measuring ranges	20MΩ/200MΩ/2000MΩ
Output voltage on open circuit	Rated test voltage +20%, -0%
Nominal current	1mA DC min.
Output short circuit current	1.5 mA DC approx.
Accuracy	±1.5%rdg±5dgt(20MΩ/200MΩ) ±10%rdg±3dgt(2000MΩ)
Continuity test	
Measuring ranges	20Ω/200Ω/2000Ω
Output voltage on open circuit	7 - 12V DC
Measuring current	200mA DC min.
Accuracy	±1.5%rdg±5dgt(20Ω) ±1.5%rdg±3dgt(200Ω/2000Ω)
AC voltage	
AC voltage range	0 - 600V AC
Accuracy	±5%rdg±3dgt
General	
Applicable Standards	IEC 61010-1 CAT III 300V Pollution degree 2 IEC 61557-1/2/4 IEC 60529(IP54) IEC 61326-1(EMC)
Power source	R6(AA)(1.5V) × 8
Dimensions	167(L) × 185(W) × 89(D)mm
Weight	990g approx.(3007A) 970g approx.(3005A)
Accessories	7122B(Test leads), 9074(Cord case) 8923(Fuse[500mA/600V]) × 1 (included), 1 (spares) R6(AA) × 8, 9121(Shoulder strap) Instruction manual

### Selection Guide

	3005A	3007A
200mA continuity range	✓	✓
Live circuit warning	✓	✓
Backlight		✓
Automatic discharge	✓	✓
Trac-Lok for extended battery life		✓

### Accessory



## KEW 3021A/3022A/3023A



photo : 3021A

- Fast response and quick insulation test.
- 3 functions in one unit, insulation test with 4 voltage ranges, continuity test, AC voltage measurement.
- 200mA measuring current on continuity testing.
- Comparator function with PASS / FAIL and buzzer.
- 0Ω adjustment at continuity measuring range.
- Memory function up to 99 data.
- Backlight LCD provides easy reading in dark locations.
- Safety lock system prevents an erroneous operation

	3021A				3022A				3023A			
Insulation resistance												
Test voltage	125V	250V	500V	1000V	50V	100V	250V	500V	100V	250V	500V	1000V
Measuring range (Auto range)	4.000/40.00/200.0MΩ	4.000/40.00/400.0/2000MΩ			4.000/40.00/200.0MΩ	4.000/40.00/400.0/2000MΩ	4.000/40.00/200.0MΩ	4.000/40.00/2000MΩ	4.000/40.00/200.0MΩ	4.000/40.00/400.0/2000MΩ		
First effective measuring range	0.2 - 20MΩ	0.2 - 40MΩ	0.2 - 200MΩ	0.2 - 1000MΩ	0.2 - 20MΩ	0.2 - 40MΩ	0.2 - 200MΩ	0.2 - 20MΩ	0.2 - 40MΩ	0.2 - 200MΩ	0.2 - 1000MΩ	
Mid-scale value	5MΩ		50MΩ		5MΩ		50MΩ	5MΩ	50MΩ		50MΩ	
Accuracy	±2%rdg±6dgt											
Second effective measuring range lower	0.110 - 0.199MΩ											
Second effective measuring range upper	20.01 - 200.0MΩ	40.01 - 2000MΩ	200.1 - 2000MΩ	100.1 - 2000MΩ	20.01 - 200.0MΩ	40.01 - 2000MΩ	200.1 - 2000MΩ	20.01 - 200.0MΩ	40.01 - 2000MΩ	200.1 - 2000MΩ	100.1 - 2000MΩ	
Accuracy	±5%rdg±6dgt											
Rated current	DC 1 - 1.2mA											
Output short circuit current	1.5mA max											
Ω/Continuity												
Auto range	40.00/400.0Ω											
Accuracy	±2%rdg±8dgt											
Output voltage on open circuit	5V±20%											
Output short circuit current	DC 220±20mA											
Fuse	Quick acting ceramic fuse 0.5A/600V(φ6.35 × 32mm)											
AC voltage												
Range	AC 20 - 600V(50/60Hz) DC -20 - -600V/+20 - +600V											
Accuracy	±3%rdg±6dgt											
General												
Applicable Standards	IEC 61010-1 CAT III 600V IEC 61557-1,2,4 IEC 61326-1(EMC) IEC 60529(IP40)											
Dimensions / Weight	105(L) × 158(W) × 70(D)mm / 600g approx.											
Power source	R6 × 6 or LR6 × 6											
Accessories	7150A(Test Lead with remote control switch set), 8923(Fuse[0.5A/600V])× 1 (included), 1 (spares) 9121(Shoulder strap), R6(AA) × 6, Instruction manual											
Optional	8016(Hook type prod), 9089(Carrying case)											

### Accessory



### Optional Accessories





# DIGITAL INSULATION/CONTINUITY TESTERS

## KEW 3551/3552/3552BT

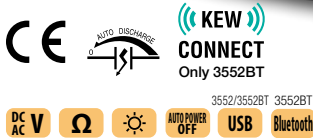

photo : 3552BT

- World's fastest measurement speed (0.5 sec.)
- Six ranges available for insulation resistance test (50/100/125/250/500/1000 V)
- Various lineup definitely fulfills your needs

### KEW CONNECT

Using our Application the measurements can be taken and automatically saved, reducing the necessity to take notes in the field. (only 3552BT)



3551/3552/3552BT						
<b>Insulation resistance</b>						
Test voltage	50V	100V	125V	250V	500V	1000V
Measuring range (Auto range)	4.000/40.00/100.0MΩ	4.000/40.00/200.0MΩ	4.000/40.00/250.0MΩ	4.000/40.00/500.0MΩ	4.000/40.00/400.0/2000MΩ /20GΩ <sup>*1</sup>	4.000/40.00/400.0/4000MΩ /40GΩ <sup>*1</sup>
Mid-scale value	2MΩ	5MΩ		10MΩ	100MΩ	200MΩ
First effective measuring ranges	0.100-10.00MΩ	0.100-20.00MΩ	0.100-25.00MΩ	0.100-50.0MΩ	0.100-500MΩ	0.100-1000MΩ
Accuracy	±2%rdg±2dgt					
Second effective measuring ranges	0.050-0.099MΩ					
Accuracy	±5%rdg					
Rated current	1.0-1.1mA					
Output short circuit current	1.5mA max					
<b>Ω/Continuity<sup>*3</sup></b>						
Auto range	40.00/400.0/4000Ω					
Accuracy	±2.5%rdg±8dgt					
Open-circuit voltage	5V(4-6.9V)					
Measuring current	200mA					
<b>Voltage</b>						
Range	AC 2.0-600V(45-65Hz)DC -2.0--600V +2.0--+600V					
Accuracy	±1%rdg±4dgt					
<b>General</b>						
Applicable Standards	IEC 61010 CAT III 600V/CAT IV 300V IEC 61557-1,2,4 IEC 61326-1,-2-2 IEC 60529(IP40)					
Communication Interface	USB <sup>*1</sup> , Bluetooth <sup>®</sup> 4.0 <sup>*2</sup>					
Dimensions/Weight	97(L)x156(W)x46(D)mm/490g approx.(including battery)					
Power source	LR6/R6(AA)(1.5V) x 4					
Accessories	7260(Test leads with remote control switch), 7261A(Test leads with alligator clip) 8017A(Extension prod long), 9173(Carrying case), 9121(Shoulder strap) LR6(AA)x4 Instruction manual					
Optional	9186A(Carrying case), 9187(Cord case), 7243A(L-shaped probe) 8016(Hook type prod) 8212-USB(USB adaptor with "KEW Report(Software)") <sup>*1</sup>					

<sup>\*1</sup> 3552/3552BT only <sup>\*2</sup> 3552BT only, Bluetooth<sup>®</sup> is a trademark or registered trademark of Bluetooth sig. Inc. Some countries regulate the compliance with their Radio Law of the products equipped with Bluetooth<sup>®</sup>. Please confirm it with your distributor before purchasing our products equipped with Bluetooth<sup>®</sup>.  
<sup>\*3</sup> Low-resistance range is protected by a built-in fuse (0.5 A / 1000 V, Dia. 6.3 x 32 mm)

### Diagnostic Insulation Tests

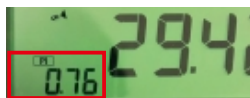

#### PI

#### Polarization Index

PI =  $\frac{\text{Insulation resistance value 10 min. after start}}{\text{Insulation resistance value 1 min. after start}}$

PI Criteria	4.0 or more Best	4.0-2.0 Good	2.0-1.0 Warning	1.0 or less Bad
-------------	------------------	--------------	-----------------	-----------------



#### DAR

#### Dielectric Absorption Ratio

DAR =  $\frac{\text{Insulation resistance value 1 min. after start}}{\text{Insulation resistance value 15 sec. after start}}$

DAR Criteria	1.4 or more Best	1.25-1.0 Good	1.0 or less Bad
--------------	------------------	---------------	-----------------

### LED light & Display backlight

Facilitate working at dimly illuminated location. Automatic sensor turns the LCD backlight and LED spot light ON/OFF.

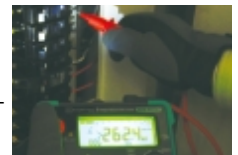

### Memory/ data transfer function (available on KEW3552/ 3552BT)

Internal memory up to 1000 measurements can be transferred to a PC by the optional adaptor 8212-USB.

## Accessories



#### MODEL 7260

Test leads with remote control switch



#### MODEL 7261A

Test leads with alligator clip



#### MODEL 9173

Carrying case

#### MODEL 8017A

Extension prod long

#### MODEL 9121

Shoulder strap



## Optional Accessories



#### MODEL 7243A

L-shaped probe



#### MODEL 8212-USB

USB adaptor with "KEW Report (Software)"



#### MODEL 9186A

Carrying case



#### MODEL 9187

Cord case



#### MODEL 8016

Hook type prod

# ANALOGUE INSULATION/CONTINUITY TESTERS

## MODEL 3131A



- Test insulation up to 100MΩ at 250V, 200MΩ at 500V, 400MΩ at 1000V and continuity up to 20Ω.
- LIVE circuit warning lamp plus audible warning.
- Automatic discharge of circuit capacitance when TEST button is released.
- Fuse protected (continuity range only).
- Battery check LED.
- Front panel zero adjust.
- Back light function to facilitate working at dimly lit situations.
- PRESS TO TEST button with lock down feature.

3131A	
Insulation resistance	
Test voltage	250V/500V/1000V
Measuring ranges (Mid-scale value)	100MΩ/200MΩ/400MΩ (1MΩ) (2MΩ) (4MΩ)
Output voltage on open circuit	Rated test voltage +20%, -0%
Nominal current	1mA DC min.
Output short circuit current	1.3 mA DC approx.
Accuracy	0.1 - 10MΩ/0.2 - 20MΩ/0.4 - 40MΩ (Accuracy guaranteed ranges) ±5% of indicated value
Continuity	
Measuring ranges (Mid-scale value)	2Ω/20Ω (1Ω)(10Ω)
Output voltage on open circuit	4 - 9V DC
Measuring current	200mA DC min.
Accuracy	±3% of scale length
General	
Applicable Standards	IEC 61010-1 CAT III 300V Pollution degree 2 IEC 61557-1/2/4 IEC 60529(IP54) IEC 61326-1(EMC)
Power source	R6(AA)(1.5V) × 6
Dimensions	167(L) × 185(W) × 89(D)mm
Weight	860g approx.
Accessories	7122B(Test leads) 9074(Cord case) 8923(Fuse[0.5A/600V]) × 1 (included), 1 (spares) R6(AA) × 6, 9121(Shoulder strap), Instruction manual

## MODEL 3132A



- Dust and drip proof construction. (designed to IEC 60529 IP54)
- Designed to meet IEC 61010-1 and IEC 61557 safety standard.
- 1mA rated test current at the minimum resistance.
- 200mA measuring current on continuity testing.
- Automatic discharge of circuit capacitance.  
(Any charge stored in the circuit under test will be automatically discharged after testing.)
- Live circuit warning buzzer and neon lamp.
- Small and lightweight. Shock resistant new case material.
- AC voltmeter with linear, easy-to-read scale.
- Operates on AA, R6 × 6 dry batteries.

3132A	
Insulation resistance	
Test voltage	250V/500V/1000V
Measuring ranges (Mid-scale value)	100MΩ/200MΩ/400MΩ (1MΩ) (2MΩ) (4MΩ)
Output voltage on open circuit	Rated test voltage +20%, -0%
Nominal current	1mA DC min.
Output short circuit current	1 - 2mA DC
Accuracy	0.1 - 10MΩ/0.2 - 20MΩ/0.4 - 40MΩ (Accuracy guaranteed ranges) ±5% of indicated value
Continuity	
Measuring ranges (Mid-scale value)	3Ω/500Ω(1.5Ω/20Ω)
Output voltage on open circuit	4.1V DC approx.
Measuring current	210mA DC min.
Accuracy	±1.5% of scale length
AC voltage	
AC voltage range	0 - 600V AC
Accuracy	±5% of scale length
General	
Applicable Standards	IEC 61010-1 CAT III 600V Pollution degree 2 IEC 61557-1/2/4 IEC 60529(IP54) IEC 61326-1(EMC)
Power source	R6(AA)(1.5V) × 6
Dimensions	106(L) × 160(W) × 72(D)mm
Weight	560g approx.
Accessories	7122B(Test leads)* 9074(Cord case) 8923(Fuse[0.5A/600V]) × 1 (included), 1 (spares) R6(AA) × 6, 9121(Shoulder strap), Instruction manual

\* 7217A(For Australia)

## Accessory

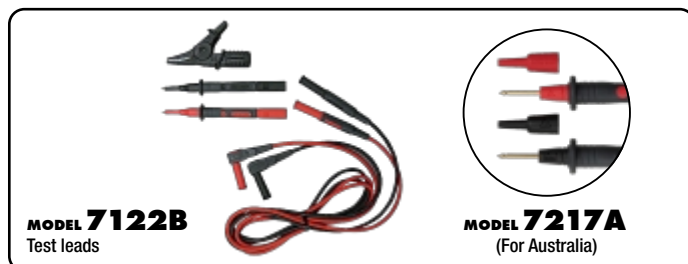

## Selection Guide

	3131A	3132A
3 range insulation test voltage	✓	✓
200mA continuity	✓	✓
Live circuit warning	✓	✓
AC voltage range	✓	✓
Illuminated scale	✓	
Automatic discharge	✓	✓
IP54 rate	✓	✓



# ANALOGUE INSULATION TESTERS

## MODEL 3161A



AC V



- Miniature lightweight insulation tester. It weighs only 340g(battery included), but carries full measurement functions.
- Automatic discharge of circuit capacitance.
- Test leads with remote control switch .
- New robust housing case.
- Back light function.

3161A	
Insulation resistance	
Test Voltage	15V/500V
Max. effective scale value	20MΩ/100MΩ
Mid-scale value	0.05MΩ/2MΩ
First effective measuring ranges	0.005 - 2MΩ/0.1 - 50MΩ
Accuracy	±5% of indicated value
Second effective measuring ranges	Measuring ranges other than above, 0 and ∞
Accuracy	±10% of indicated value
AC voltage	
AC voltage range	600V
Accuracy	±3% of full scale value
Applicable Standards	IEC 61010-1 CAT III 300V, CAT II 600V
Power source	R6(AA)(1.5V) × 4
Dimensions	90(L) × 137(W) × 40(D)mm
Weight	340g approx.
Accessories	7149A(Test leads with remote control switch set) 9123(Shoulder strap) R6(AA) × 4, Instruction manual
Optional	8016(Hook type prod)

## MODEL 3165/3166



AC V

- 500V/1000MΩ (Model 3165)
- 1000V/2000MΩ (Model 3166)
- Expanded megohm scale for easy reading.
- New robust housing case to prevent damage.
- AC voltmeter scale for easy reading.

photo : 3165

	3165	3166
Insulation resistance		
Test voltage	500V	1000V
Max. effective scale value	1000MΩ	2000MΩ
Mid-scale value	20MΩ	50MΩ
First effective measuring range	1 - 500MΩ	2 - 1000MΩ
Accuracy	±5% rdg	
Second effective measuring range	0.5/1000MΩ	1/2000MΩ
Accuracy	±10% rdg	
AC voltage		
AC voltage range	600V	
Accuracy	±3% of full scale value	
Power source	R6(AA)(1.5V) × 4	
Dimensions	90(L) × 137(W) × 40(D)mm	
Weight	330g approx.	
Accessories	7025(Test leads), 9074(Cord case), 9123(Shoulder strap) R6(AA) × 4, Instruction manual	

## KEW 3431



DC V

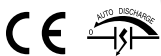

- Compact and lightweight design.
- Scale light and LED spot light to facilitate working at dimly illuminated location or at nighttime work.
- Built-in illuminance sensor automatically turns on off the lights.
- Test probe with remote control switch is supplied as standard accessory.
- Live circuit warning with blinking LED and buzzer.

3431		
Insulation resistance		
Test Voltage	250V	500V
Max. effective scale value	200MΩ	2000MΩ
Mid-scale value	5MΩ	50MΩ
First effective measuring ranges	0.1MΩ - 100MΩ	1MΩ - 1000MΩ
Accuracy	±5% of indicated value	
Second effective measuring ranges	Measuring ranges other than above, 0 and ∞	
Accuracy	±10% of indicated value	
Voltage measurement		
Voltage	AC 600V (45 - 65Hz)/DC 600V	
Accuracy	±5% of indicated value	
Applicable Standards	IEC 61010-1, 2-030 CAT III 600V Pollution degree 2, IEC 61010-031	
Power source	LR6/R6(AA)(1.5V) × 4	
Dimensions	97(L) × 156(W) × 46(D)mm	
Weight	430g approx.	
Accessories	7260(Test lead with remote control switch set), 7261A(Test lead with alligator clip), 9173(Carrying case), 8017A(Extension prod long), 9121(Shoulder strap), LR6(AA) × 4, Instruction manual	
Optional	9186A(Carrying case), 9187(Cord case) 7243A(L-shaped probe), 8016(Hook type prod)	

# INSULATION TESTERS

## Why insulation test is necessary?

All live conductors of electrical appliances and installations must be insulated to prevent electric shock hazards from inadvertent contact, fire hazards from short circuit and equipment damage. In addition, a low insulation resistance in installation will result in a leakage current, and hence causes a waste of energy which would increase the running costs of the installation. Insulation resistance must be checked by applying appliances or installations a higher voltage than its normal working voltage,

because an insulation resistance is lower at higher voltage than at lower voltage. Kyoritsu's insulation resistance testers provide measurement at high levels of test voltages. Periodical test is also important to ensure that insulation of installations or appliances is not deteriorating. Foreign matter and mechanical factors like wear or breakage may reduce insulation resistance. Regular tests and data logs can detect possible fault in insulation.

## Standards and applications

The International Standard of Electrical Installation of Buildings IEC 60364 has a dedicated section named "Verification". This can be found in part 6. This section stipulates minimum values for the insulation resistance, measured with a particular test voltage, with no equipment connected to the circuits.

Nominal circuit voltage	Test voltage in d.c. applied by Insulation tester	Insulation resistance value
SELV, PELV ( $\leq 50V$ a.c. $\leq 120V$ d.c.)	250V	$\geq 0.5M\Omega$
Up to and including 500 V (including FELV) with the exception of the above cases	500V	$\geq 1M\Omega$
Above 500V	1000V	$\geq 1M\Omega$

The testing apparatus (insulation testers) have to be capable of supplying an output current of at least 1mA at its nominal test voltage.

According to IEC 60364, a typical for 230/400V electrical installation (excluding SELV and PELV), requires that the insulation resistance at a test voltage of 500 V d.c. is larger than 1 M $\Omega$ .

A test voltage of 1000V can be used for testing the insulation resistance of large electric motors, switchboards, industrial processing machines, devices and circuits with voltages exceeding 500V (but below 1000V a.c. and 1500V d.c.).

A test voltage lower than 250V (for example 15V, 50V, 100V and 125V) may be available in some insulation testers for testing the insulation resistance in telecommunication devices and circuits, security devices, local networks, speech (audio) devices, delicate electronic circuits and PCBs.

## Insulation Testing Methods

### ■ Measurement of Insulation resistance between live conductors (A)

Prior to testing, make sure that the circuit or part of the installation to be tested is disconnected from the mains supply and not energized. It is also necessary to ensure: the point of the installation to be checked is not open due to other equipment incorporated, the load connected with a fixed load and socket outlet is disconnected from the mains supply, and relay coils, fluorescent lamps, etc do not produce continuity between conductors. Circuits or components likely to be damaged by insulation test voltage must be removed from the circuit under test. If they cannot be disconnected, an alternative testing method is to measure insulation resistance between live conductors and earth.

### ■ Measurement of insulation resistance between live conductors and earth (B)

The test must be carried out with equipment always disconnected, i.e., with the mains switch open it must be disconnected from the mains supply. Earth terminal must be connected to earth and Line terminal to a live conductor or conductors. Where there is insulation deterioration or an indoor electrical installation is not partly or totally insulated a variety of electric hazards may be anticipated.

To give some of the examples;

- Leakage current dangerous to the human body will develop. This is particularly the case with equipment that has no good earth and therefore is not properly protected against the potential difference.
- Overheating of conductors due to the leakage of current or microscopic discharging will cause short circuits or fires.
- RCDs will trip, with resulting damage to the equipment which will also cause short circuits and fires.

Kyoritsu's dedicated leakage clamp meters MODEL 2431, 2432, 2433, 2433R, 2434, KEW 2413F and 2413R will be very helpful in identifying the possible causes of such accidents.

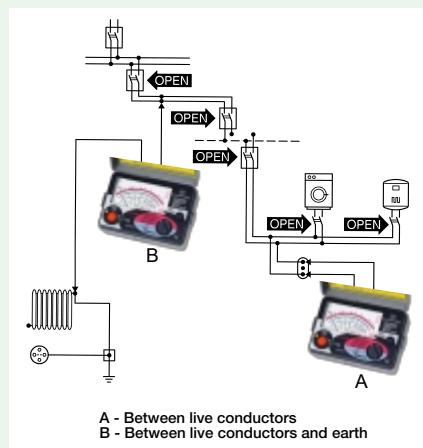

# HIGH VOLTAGE INSULATION TESTERS

2500V 5000V  
**KEW 3121B/3122B**



photo : 3121B



photo : 3122B

- Easy and simple operation.
- Automatic ranges, indicated by different LED's.
- Newly-designed alligator clip.
- It comes with a tough hard case.
- Safety standard IEC 61010-1 CAT IV 300V

CE

	3121B	3122B
Test voltage	2500V	5000V
Measuring ranges (automatic change)	2GΩ/100GΩ (auto ranging)	5GΩ/200GΩ (auto ranging)
First effective measuring ranges	0.1 - 50GΩ	0.2 - 100GΩ
Accuracy	±5% rdg	
Other ranges accuracy	±10% rdg or 0.5% of scale length	
Short circuit current	0.08mA	
Applicable Standards	IEC 61010-1, 61010-2-030 CAT IV 300V, CAT III 600V Pollution degree 2, IEC 61326-1, 61326-2-2(EMC), IEC 60529(IP40)	
Power source	DC12V:LR14 × 8	
Dimensions	177(L) × 226(W) × 100(D) mm	
Weight	1.6kg approx.	1.7kg approx.
Accessories	7165A(Line probe)(3m), 7264(Earth cord)(3m), 7265(Guard cord)(3m), 8019(Hook type prod), 9182(Carrying case[Hard]), LR14 × 8, Instruction manual	7165A(Line probe)(3m), 7264(Earth cord)(3m), 7265(Guard cord)(3m), 8019(Hook type prod), 9183(Carrying case[Hard]), LR14 × 8, Instruction manual
Optional	7168A(Line probe with alligator clip)(3m), 7253(Longer line probe with alligator clip)(15m), 8324(Adaptor for recorder)	

## Optional Accessories

**MODEL 7168A**  
Line probe with alligator clip : 3000mm

**MODEL 7253**  
Longer line probe with alligator clip:15m

**MODEL 8324**  
Adaptor for recorder (Output 10mV/1μA)  
Cable length : 200mm  
Alligator clip side : 1100mm

# HIGH VOLTAGE INSULATION TESTERS

10000V

## KEW 3123A



	3123A	
Test voltage	5000V	10000V
Measuring ranges (automatic change)	5GΩ/200GΩ (autoranging)	10GΩ/400GΩ (autoranging)
First effective measuring ranges	0.2 - 100GΩ	0.4 - 200GΩ
Accuracy	±5% rdg	
Other ranges accuracy	±10% rdg or 0.5% of scale length	
Power source	R6(AA)(1.5V) × 8	
Dimensions	200(L) × 140(W) × 80(D)mm	
Weight	1kg approx.	
Accessories	7165A(Line probe)(3m), 7224A(Earth cord)(1.5m), 7225A(Guard cord)(1.5m), 8019(Hook type prod), 9158(Carrying case [Hard]), R6(AA) × 8, Instruction manual	
Optional	7253(Longer line probe with alligator clip)(15m), 7168A(Line probe with alligator clip)(3m), 8324(Adaptor for recorder)	

- Rugged design with a hard carrying case for field use.
- Detachable High Voltage Line probe.
- Automatic ranges, high and low scales, indicated by different LEDs.
- Drip proof.
- Auto-discharge function.

### Accessories

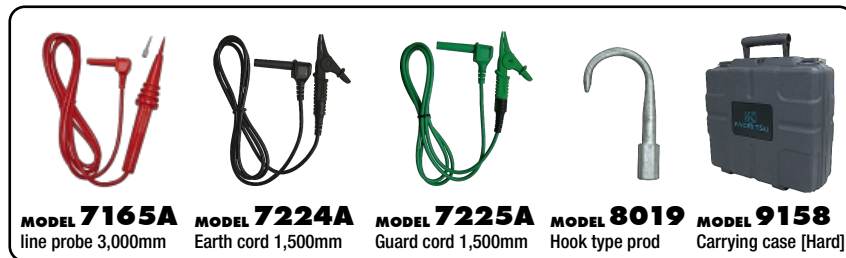

### Optional Accessories



### Use of Guard Terminal

Illustrated in this Fig. is an example of the insulation resistance measurement of an electric wire. If the line probe is simply connected to the wire conductor and the earth lead to the immersion liquid container as shown, a measurement error will be introduced as this results in the measurement of the combined resistance of insulation resistance and the surface leakage resistance at the cut end of the electric wire. In order to remove this surface leakage current, wind a guard wire around the cut end of the conductor and connect it to the guard terminal of the instrument using the guard lead. Then, the surface leakage current will bypass the indicating meter of the insulation resistance tester.

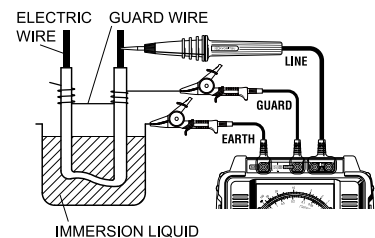

10000V

## KEW 3124A



External Power Supply

	3124A	
Test voltage	1k - 10kV variable	1000V
Measuring ranges (automatic change)	1.6GΩ/100GΩ (autoranging)	100MΩ
First effective measuring ranges	0.05 - 50GΩ	1 - 100MΩ
Accuracy	±10% rdg	
Other ranges accuracy	±1% of scale length	
Output voltage and set voltage indicate	DC 0 - 10kV ±2%rdg±2dgt	
Power source	Ni-MH rechargeable battery(1.2V) × 8	
Dimensions	200(L) × 140(W) × 80(D)mm	
Weight	1.5kg approx.	
Accessories	7082(Lead for recorder), 7083(Lead for battery charging), 7084(Earth and guard leads), 9176(Carrying case[Hard]), 8266(Battery charger[120V]) or 8267(Battery charger[220V]), 8268(Ni-MH rechargeable battery × 8), Instruction manual	

### Accessories

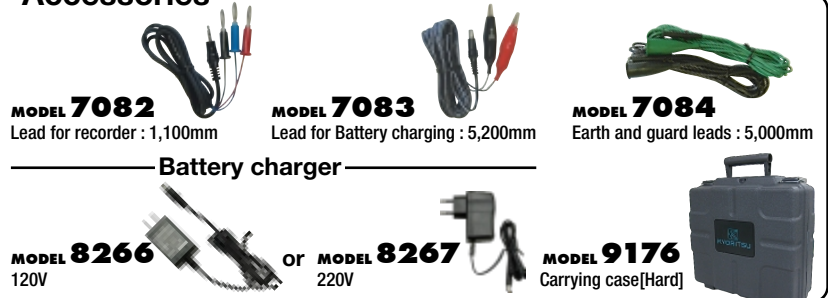

- Permits a wide range of insulation testing up to 100GΩ at variable test voltage from 1kV to 10kV.
- DC voltage output for recorders.
- Output voltage is shown on the digital display.
- After tests, automatically discharges the charges stored in the circuit under test.
- Operated by Ni-MH rechargeable batteries.



# HIGH VOLTAGE INSULATION TESTERS

2500V

5000V

KEW **3025A/3125A**



photo : 3125A

DC V AC V AUTO POWER OFF

- Large digital display with Bar Graph indication and back light.
- Polarization Index measurement(PI)
- Dielectric Absorption Ratio(DAR).
- Indication of Output voltage and Discharge voltage.
- Safety standard IEC 61010-1 CAT IV 300V / CAT III 600V



photo : 3025A



3025A/3125A						
Range	Insulation resistance					Voltage measurement
Test voltage	250V	500V	1000V	2500V	5000V*1	
Measuring range	0.0 - 100.0MΩ	0.0 - 99.9MΩ 80 - 1000MΩ	0.0 - 99.9MΩ 80 - 999MΩ 0.80 - 2.00GΩ	0.0 - 99.9MΩ 80 - 999MΩ 0.80 - 9.99GΩ 8.0 - 100.0GΩ	0.0 - 99.9MΩ 80 - 999MΩ 0.80 - 9.99GΩ 8.0 - 99.9GΩ 80 - 1000GΩ	30 - 600V AC/DC (50/60Hz)
Accuracy	±5%rdg±3dgt	±5%rdg±3dgt	±5%rdg±3dgt	±5%rdg±3dgt	±5%rdg±3dgt ±20%(100GΩ or more)	±2%rdg±3dgt
Short circuit current	1.5mA					—
Rated test current	0.7mA - 0.9mA at 0.25MΩ load	0.8mA - 1mA at 0.5MΩ load	1mA - 1.2mA at 1MΩ load	1mA - 1.2mA at 2.5MΩ load	1mA - 1.2mA at 5MΩ load	—
Open circuit voltage	250V +10%, -10%	500V +20%, -10%	1000V +20%, -0%	2500V +20%, -0%	5000V +20%, -0%	—
Applicable Standard	IEC 61010-1, 61010-2-030 CAT IV 300V, CAT III 600V Pollution degree 2, IEC 61326-1, 2-2					
Power source	DC12V:LR14 × 8					
Dimensions	177(L) × 226(W) × 100(D) mm					
Weight	1.7kg approx. (3025A) 1.9kg approx. (3125A)					
Accessories	7165A(Line probe)(3m), 7264(Earth cord)(3m), 7265(Guard cord)(3m), 8019(Hook type prod), 9180(Carrying case for 3025A) 9181(Carrying case for 3125A), LR14(Alkaline battery size C) × 8, Instruction manual					
Optional	7168A(Line probe with alligator clip)(3m), 7253(Longer line probe with alligator clip)(15m), 8302(Adaptor for recorder)					

\*1) KEW3125A only

## Accessories



**MODEL 7165A**  
Line probe 3,000mm



**MODEL 7264**  
Earth cord 3,000mm



**MODEL 7265**  
Guard cord 3,000mm



**MODEL 8019**  
Hook type prod



**MODEL 9180/9181**  
Carrying case [Hard]  
9180(3025A)/9181(3125A)

# HIGH VOLTAGE INSULATION TESTERS

5000V

KEW **3127**

CAT IV 600V DC AC V USB Bluetooth

- Insulation Resistance up to 10TΩ
- Short-Circuit Current up to 5mA
- Wide Test Voltage from 250V to 5000V
- Diagnostic Insulation Tests: IR, PI, DAR, DD, SV, RAMP.
- Wireless communication by Bluetooth for transferring and showing real-time data to PC and Android device.
- Memory and Logging functions.
- Filter function reduces noise interference.
- Robust design for field use with IP65 (lid closed).
- Powered by rechargeable battery.

Function

**PI** **DAR** **DD** **SV** **RAMP**



HIGH VOLTAGE INSULATION TESTERS

## 3127

Insulation resistance		250V *1	500V	1000V	2500V	5000V
Test voltage		250V *1	500V	1000V	2500V	5000V
Max measurement value		9.99GΩ	99.9GΩ	199GΩ	999GΩ	9.99TΩ
Accuracy		0.0 - 99.9MΩ ±5%rdg±3dgt	0.0 - 999MΩ ±5%rdg±3dgt	0.0 - 1.99GΩ ±5%rdg±3dgt	0.0 - 99.9GΩ ±5%rdg±3dgt	0.0 - 99.9GΩ ±5%rdg±3dgt
		0.1G - 9.99GΩ ±20%rdg	1G - 99.9GΩ ±20%rdg	2G - 199GΩ ±20%rdg	100G - 999GΩ ±20%rdg	0.1T - 9.99TΩ ±20%rdg
Short circuit current		Max 5.0mA				
Output voltage	Accuracy	-10 - +10%	-10 - +20%	0 - +20%		
	Variable				-20% - 0% (5%step)	
Monitor		±10%rdg±20V				
Measuring range	Voltage measurement	AC:30 - 600V (50/60Hz) DC:±30 - ±600V		Current measurement	Capacitance measurement	
	Accuracy	±2%rdg±3dgt		0.00nA - 5.50mA	5.0nF - 50.0μF *2	
Power source		Rechargeable Battery (Lead-acid Battery) 12V*4 Charging power : DC 15VA MAX				
Communication Interface		Bluetooth®:Ver2.1 + EDR Class2 , USB:Ver1.1				
Applicable Standards		IEC 61010-1, 61010-2-030 CAT IV 600V Pollution degree2, IEC 61326-1, 2-2				
Dimension		208(L) × 225(W) × 130(D) mm (Hard case 380(L) × 430(W) × 154(D) mm)				
Weight		3127:4kg Approx. (including battery), Total:8kg Approx. (including Accessories)				
Accessories		7165A(Line probe), 7224A(Earth cord), 7225A(Guard cord), 8019(Hook type prod), 8327EU(Power adaptor 15V/1A), 9171(Carrying case[Hard]), Instruction manual				
Optional		7168A(Line probe with alligator clip:3m), 7253(Longer line probe with alligator clip:15m), 8258(USB communication set), 8302(Adaptor for recorder 1mV/1μA)				

\*1) IR mode only \*2) At 5000V range 5.0nF-25.0μF \*3) Determined by resistance and Voltage values (over 10MΩ) \*4) No measurements are possible while charging ※ Bluetooth® is a registered trademark of the Bluetooth SIG, Inc.

### Data Communication Function

- Transferring and showing real-time data to PC and Android tablet
- Recorded data can be transferred (PC only)
- Analyzing of the saved data (PC only)



### Optional Accessories



### Diagnostic Insulation Tests

#### PI Polarization Index

$$PI = \frac{\text{Insulation resistance value 10 min. after start}}{\text{Insulation resistance value 1 min. after start}}$$

PI Criteria	4.0 or more Best	4.0-2.0 Good	2.0-1.0 Warning	1.0 or less Bad
-------------	------------------	--------------	-----------------	-----------------

#### DAR Dielectric Absorption Ratio

$$DAR = \frac{\text{Insulation resistance value 1 min. after start}}{\text{Insulation resistance value *15 sec. after start}}$$

DAR Criteria	1.4 or more Best	1.25-1.0 Good	1.0 or less Bad
--------------	------------------	---------------	-----------------

\*User-Selectable 15sec. or 30sec. interval

#### DD Dielectric Discharge

$$DD = \text{Current value 1 min. after completing (mA)}$$

$$DD = \text{Voltage value when a measurement complete (V)} \times \text{Capacitance (F)}$$

DD Criteria	2.0 or less Good	2.0-4.0 Warning	4.0-7.0 Poor	7.0 or more Very poor
-------------	------------------	-----------------	--------------	-----------------------





# HIGH VOLTAGE INSULATION TESTERS

12000V

## KEW 3128

CAT IV 600V DC AC V SUN USB AUTO POWER OFF External Power Supply

- Test Voltage 12kV (max), Resistance 35TΩ (max).
- Short-Circuit Current 5mA (max).
- Graphic representation of the insulation resistance and leakage current versus time on large display with bar graph and backlight.
- Print Screen Function enables to record up to 32 display screens.
- Internal Memory can store about 43,000 data (max).
- Can be operated from internal rechargeable battery or from AC line.
- Robust design for field use with IP64 rating (with lid closed).

### Function

PI DAR DD SV



		3128						
		500V	1000V	2500V	5000V	10000V	12000V	
Insulation resistance	Test voltage	500V	1000V	2500V	5000V	10000V	12000V	
	Max measurement value	500GΩ	1TΩ	2.5TΩ	5TΩ	35TΩ		
	Accuracy	400kΩ - 50GΩ ±5%rdg±3dgt	800kΩ - 100GΩ ±5%rdg±3dgt	2MΩ - 250GΩ ±5%rdg±3dgt	4MΩ - 500GΩ ±5%rdg±3dgt	8MΩ - 1TΩ ±5%rdg±3dgt		
		50G - 500GΩ ±20%rdg	100G - 1TΩ ±20%rdg	250G - 2.5TΩ ±20%rdg	500G - 5TΩ ±20%rdg	1T - 10TΩ ±20%rdg		10T - 35TΩ Values are displayed, but accuracy isn't guaranteed
Short circuit current		Max 5.0mA						
Load resistor to output rated voltage		0.5MΩ or more	1MΩ or more	2.5MΩ or more	5MΩ or more	20MΩ or more	24MΩ or more	
Output voltage	Rated voltage	500V	1000V	2500V	5000V	10000V	12000V	
	Monitor accuracy	±10%±20V						
	Output accuracy	0 - +20%	0 - +10%	0 - +10%	0 - +10%	-5 - +5%	-5 - +5%	
Voltage measurement	Selectable range	50 - 600V (in steps of 5V)	610 - 1200V (in steps of 10V)	1225 - 3000V (in steps of 25V)	3050 - 6000V (in steps of 50V)	6100 - 10000V (in steps of 100V)	10100 - 12000V (in steps of 100V)	
	Measuring range	DCV : ±30 - ±600V, ACV : 30 - 600V(50/60Hz)						
Current measurement	Accuracy	±2%rdg±3dgt						
	Measuring range	5.0nA - 2.40mA(Depending on the insulation resistance)						
Capacitance measurement	Accuracy	±5%rdg±5dgt						
	Measuring range	5.0nF - 50.0μF					5.0nF - 1.0μF (Display range : 5.0nF - 50.0μF)	
General	Accuracy	±5%rdg±5dgt						
	Applicable Standards	IEC 61010-1 CAT IV 600V Pollution degree 2, IEC 61326, IEC 60529(IP64): with the lid closed.						
	Power source	Rechargeable Lead storage battery (12V *Charging time : approx. 8 hours) / AC Power supply (100V - 240V, 50/60Hz) ※ Continuous measuring time: approx. 4 hours a load of 100MΩ at the Insulation resistance 12000V Range.						
	Dimensions	330(L) × 410(W) × 180(D)mm *Instrument and Hard case						
	Weight	9kg approx. (including battery) *Instrument and Hard case						
	Accessories	7170(Power cord), 7224A(Earth cord), 7225A(Guard cord), 7226A(Line probe), 7227A(Line probe with alligator clip), 8029(Extension prod), 8212-USB-W(USB adaptor with KEW Windows(Software)), Instruction manual						
Optional	7254(Longer line probe with alligator clip)(15m)							

### SV SV Measurement (Step Voltage)

During the test, the applied voltage incrementally steps by a certain voltage taking successive 5-time measurement. Degradation of insulation may be doubted when insulation resistances become lower at higher applied voltages.



### RAMP RAMP TEST

Voltage used in Step voltage test is raised in steps but that used in Ramp measurement is gradually raised.

The KEW 3127 Ramp test generates a rising voltage ramp up to the selected voltage.

#### [Breakdown Mode]

KEW 3127 automatically stops the test if the insulation breaks down in order to prevent damage to the object being tested.

#### [Burn Mode]

KEW 3127 allows the insulation test voltage to continue even after the insulation breaks down. This enables you to locate a fault, such as pinholes in windings, by seeing a spark or a wisp of smoke.

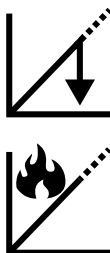

### Large Graphical Display

Graphic representation of the insulation resistance and leakage current versus time on large display with bar graph and backlight.

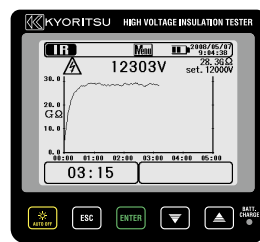

### "KEW Windows" Software for report

The stored data can be transferred to PC via MODEL8212-USB-W.



#### System requirements

OS: Windows® 11/10/8.1/8  
Display: XGA (Resolution 1024 × 768 dots) or more  
Hard-disk: Space required 100Mbyte or more  
Others: With CD-ROM drive and USB port  
NET Framework(2.0 or more)  
\* Windows® is a registered trademark of Microsoft in the United States.

### Optional Accessory

MODEL 7254

Longer line probe with alligator clip : 15m



# EARTH TESTERS

EARTH TESTERS



# EARTH TESTERS

## Measurement of the earth electrode resistance (3-Pole method)

[MODEL 4102A/KEW 4105A/KEW 4105DL]

The international standard IEC 60364-6 provides information regarding the measurement of the resistance of an earth electrode for TT, TN and IT systems. This measurement shall be made by the Volt-Amperometric method using two auxiliary earth electrodes. The instrument that covers this requirement is the Earth Tester.

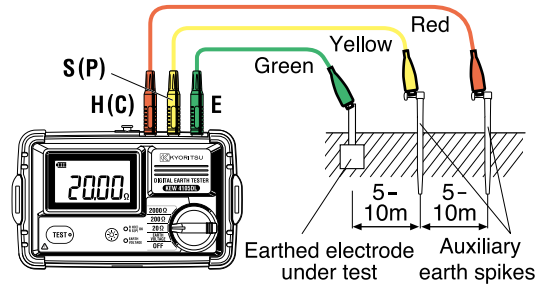

Precise Measurement

## Measurement of the simplified earth resistance (2-Pole method)

[KEW 4300/MODEL 4102A/KEW 4105A/KEW 4105DL]

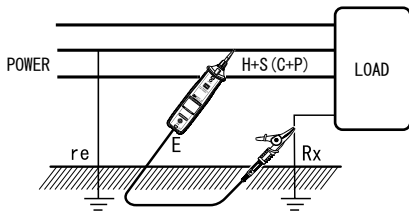

Measuring the earth resistance of load

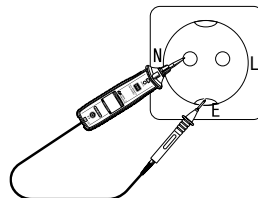

Measuring the earth resistance of wall socket

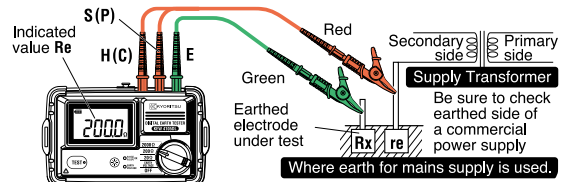

Simplified Measurement

## Measurement of the earth resistance with Earth Clamp (Why earth measurements can be found by only clamping it?)

[MODEL 4200/KEW 4202]

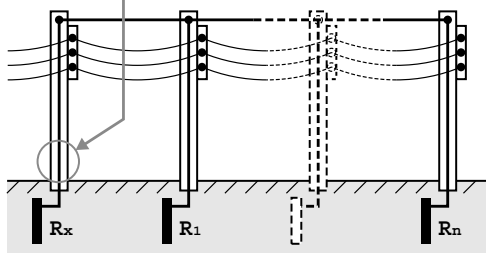
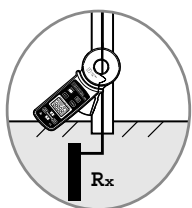

R<sub>x</sub> is defined as earth resistance under test, and R<sub>1</sub>, R<sub>2</sub>...R<sub>n</sub> are defined as earth resistance of other measuring objects.

These earth resistances, R<sub>1</sub>, R<sub>2</sub>,... R<sub>n</sub> can be considered that they are connected in parallel. And They can be regarded as a combined resistance R<sub>s</sub>. The R<sub>s</sub> can be regarded small enough against R<sub>x</sub> since a combined resistance consists of several resistances.

Following is an equivalent circuit diagram of this circuit.

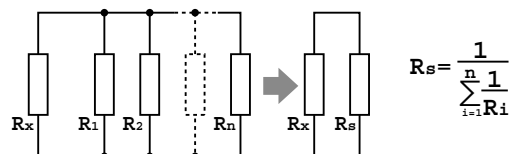

$$R_s = \frac{1}{\sum_{i=1}^n \frac{1}{R_i}}$$

Voltage V is applied to the object (Resistance R<sub>x</sub>) measured from the voltage injection transformer CT1, and the current I corresponding to the earth resistance is flowed.

$$\frac{V}{I} = R = R_x + R_s$$

$$R_x \gg R_s = \frac{1}{\sum_{i=1}^n \frac{1}{R_i}}$$

$$\frac{V}{I} = R_x$$

The current I is detected with detection transformer CT2, and object (Resistance R<sub>x</sub>) measured can be put out by the calculation. (refer to the right diagram)

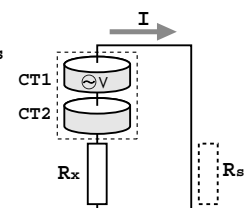

# EARTH TESTERS

## KEW 4105DL



- 3pole and 2pole Earth Resistance measurement (0.01Ω-2000Ω)
- Waterproof design (IP67)
- Rotary Switch makes the user interface very intuitive
- Large LCD Display with Backlight
- LED to monitor correct / non correct auxiliary earth spike resistance
- Earth Voltage Measurement (AC/DC 0-300V)
- CAT IV 100V

Water and dust proof: after use you can wash it to remove the mud and dust!



Adapter to enable use of other test leads



Innovative Cable reel with wire guide system to facilitate rewinding



	4105DL/4105DL-H		
Earth resistance measurement	20Ω	200Ω	2000Ω
Measuring range	0.00 - 2000 Ω		
Display range	0.00 - 20.99 Ω	0.0 - 209.9 Ω	0 - 2099 Ω
Accuracy* <sup>1</sup>	±1.5%rdg±0.08 Ω* <sup>2</sup>		
Auxiliary earth resistance* <sup>3</sup>	<10 kΩ	<50 kΩ	<100 kΩ
Comparator reference value	10 Ω	100 Ω	500 Ω
Earth voltage measurement			
Measuring range	0 - 300 V AC (45 - 65Hz)	±0 - ±300 V DC	
Display range	0.0 - 314.9 V	0.0 - ±314.9 V	
Accuracy	±1%rdg±4dgt		
Overload protection	Earth resistance:360V AC(10 Seconds) Earth Voltage:360V AC(10 Seconds)		
Applicable Standards	IEC 61010-1, CAT IV 100 V /CAT III 150 V /CAT II 300 V Pollution degree 3 IEC 61010-2-030,IEC 61010-031, IEC 61557-1, 5 IEC 60529 IP67, IEC 61326-1, -2-2		
Power source	LR6(AA)(1.5V) × 6		
Dimensions	121(L) × 188(W) × 59(D) mm (including case lid)		
Weight	Approx. 690g (including batteries and case lid)		
Accessories for 4105DL	7127B(Simplified measurement probe) 8041(Auxiliary earth spikes[2 spikes/1set]) 9121(Shoulder strap) 7267(Cable reel for Earth resistance tester (red)) 7268(Cable reel for Earth resistance tester (yellow)) 7271(Earth resistance test leads) 9190(Carrying case) , LR6(AA) × 6, Instruction manual		
Accessories for 4105DL-H	7127B(Simplified measurement probe) 8041(Auxiliary earth spikes[2 spikes/1set]) 9121(Shoulder strap) 7266(Earth resistance test leads[red-20m, yellow-10m, green-5m/1set]) 9191(Hard case) , LR6(AA) × 6, Instruction manual		
Optional	7272(Precision measurement cord set), 8259(Adapter for measurement terminal)		

\*1 For precision measurement, auxiliary earth resistance should be 100 Ω ±5% or less.  
\*2 At simplified measurement add ±0.10 Ω to the specified accuracy.  
\*3 Accuracy within the auxiliary earth resistance: ±5% rdg ±10 dgt.

KEW 4105DL Cable reel set model  
KEW 4105DL-H Hard case model

### KEW 4105DL



### KEW 4105DL-H



## Optional Accessories



**MODEL 7272**  
Precision measurement cord set  
(7267, 7268, 7271, 8041, 9192)

### < MODEL 7272 Precision measurement cord set >



**MODEL 7267**  
Cable reel for Earth resistance tester (red)



**MODEL 7268**  
Cable reel for Earth resistance tester (yellow)



**MODEL 7271**  
Earth resistance test lead



**MODEL 8041**  
Auxiliary earth spikes [2spikes/1set]



**MODEL 9192**  
Carrying case



**MODEL 8259**  
Adapter for measurement terminal  
[red, yellow, green/1 set]



# EARTH TESTERS

## MODEL 4102A



CE

4102A/4102A-H				
Earth resistance measurement	× 1Ω Range	× 10Ω	× 100Ω	
	Measuring range	0 - 12 Ω	0 - 120 Ω	0 - 1200 Ω
	Accuracy	±3% of full scale		
Earth voltage measurement				
Earth voltage measurement	Measuring range	0 - 30 V AC (50,60Hz)		
	Accuracy	±3% of full scale		
Overload protection	Earth resistance : 276V AC/DC (10 seconds) Earth voltage : 276V AC/DC (10 seconds)			
Applicable Standards	IEC 61010-1 CAT III 300 V Pollution degree 2 IEC 61010-2-030, IEC 61557-1, -5, IEC 60529 IP54			
Power source	R6(AA)(1.5V) × 6			
Dimensions	105(L) × 158(W) × 70(D) mm (including case lid)			
Weight	Approx. 600g (including batteries and case lid)			
Accessories	7095A(Earth resistance test leads [red-20m, yellow-10m, green-5m/1set]) 7127B(Simplified measurement probe), 8032(Auxiliary earth spikes[2 spikes/1set]), 9121(shoulder strap), R6(AA) × 6, Instruction manual Carrying case : 9084[Soft] : 9164[Hard]			
Optional	7245A(Precision measurement cord set), 8259(Adapter for measurement terminal)			

MODEL 4102A Soft case model  
MODEL 4102A-H Hard case model

## KEW 4105A



CE

4105A/4105A-H			
Earth resistance measurement	20Ω	200Ω	2000Ω
	Measuring range	0.00 - 1999 Ω	
	Display range	0.00 - 19.99 Ω	0.0 - 199.9 Ω
Accuracy	±2%rdg±0.1 Ω		±2%rdg±3dgt
Earth voltage measurement			
Earth voltage measurement	Measuring range	0 - 200 V AC (50,60Hz)	
	Display range	0.0 - 199.9 V	
	Accuracy	±1%rdg±4dgt	
Overload protection	Earth resistance : 280V AC (10 seconds) Earth voltage : 300V AC (1 minute)		
Applicable Standards	IEC 61010-1 CAT III 300 V Pollution degree 2 IEC 61010-2-030, IEC 61557-1, -5, IEC 60529 IP54		
Power source	R6(AA)(1.5V) × 6		
Dimensions	105(L) × 158(W) × 70(D) mm (including case lid)		
Weight	Approx. 550g (including batteries and case lid)		
Accessories	7095A(Earth resistance test leads [red-20m, yellow-10m, green-5m/1set]) 7127B(Simplified measurement probe), 8032(Auxiliary earth spikes[2 spikes/1set]), 9121(shoulder strap), R6(AA) × 6, Instruction manual Carrying case : 9084 [Soft] : 9165[Hard]		
Optional	7245A(Precision measurement cord set), 8259(Adapter for measurement terminal)		

KEW 4105A Soft case model  
KEW 4105A-H Hard case model

- In addition to the facility for precision measurement, test leads for simplified two wire measuring system also supplied as standard accessories. (unit can be hung from the neck for simplified measurement)
- The latest circuit design permits the instrument to operate with the minimum of influence from earth voltage and earth resistance of auxiliary earth spikes.
- Dust and drip proof. (designed to IEC 60529 IP54)
- Earth resistance value can be read directly from the scale.
- Designed to meet IEC 61010-1 safety standard.
- Capable of measuring earth voltage.
- Small and lightweight. Shock resistant new case material.
- 2mA measuring current permits earth resistance tests without tripping earth leakage current breakers in the circuit under test.
- Lead wire connection to C and P terminals and proper auxiliary earth resistance can be checked by "OK" lamp. Lead wire connection to C and E terminals is good when "OK" lamp is illuminated. (4102A)

## Optional Accessories



Soft case model



Hard case model



MODEL 7245A  
Precision measurement cord set  
(7228A, 8032, 8200-03, 9142)

### < MODEL 7245A Precision measurement cord set >



MODEL 7228A  
Earth resistance test leads



MODEL 8032  
Auxiliary earth spikes  
[2 spikes/1set]



MODEL 8200-03  
Cord reels[3 pcs]



MODEL 9142  
Carrying case



MODEL 8259  
Adapter for measurement terminal  
[red, yellow, green/1 set]

# EARTH TESTERS



## KEW 4106



- Earth resistance measurement with six ranges covering measurements from 0.001  $\Omega$  to 200 k $\Omega$ .
- Earth resistivity ( $\rho$ ) measurement is automatically calculated after having set the distance between Auxiliary Earth Spikes (Wenner method).
- Automatic and Manual selection of the Test Current Frequency in four bands of 94/105/111/128Hz. In Automatic mode KEW 4106 will select the most suitable Frequency.
- Advanced Filtering method (based on FFT Fast Fourier Transform) reduces noise interference for obtaining stable measurements.
- Up to 800 measurement results can be saved in the memory and recalled on the display.
- The stored results can be transferred to a PC via USB adaptor (Model 8212-USB) by using software "KEW Report" which are included.
- Robust design with IP54 protection.

4106				
Function	Range	Resolution	Measuring range	Accuracy
Earth resistance Re (Rg at $\rho$ measurement)	2 $\Omega$	0.001 $\Omega$	0.03 - 2.099 $\Omega$	$\pm 2\%rdg. \pm 0.03\Omega$
	20 $\Omega$	0.01 $\Omega$	0.03 - 20.99 $\Omega$	
	200 $\Omega$	0.1 $\Omega$	0.3 - 209.9 $\Omega$	
	2000 $\Omega$	1 $\Omega$	3 - 2099 $\Omega$	$\pm 2\%rdg. \pm 5dgt$
	20k $\Omega$	10 $\Omega$	0.03k - 20.99k $\Omega$	
Auxiliary earth resistance Rh, Rs				8% of Re+Rh+Rs
Earth resistivity $\rho$	2 $\Omega$	0.1 $\Omega$ -m - 1 $\Omega$ -m Autoranging	0.2 - 395.6 $\Omega$ -m	$\rho = 2 \times \pi \times a \times Rg$
	20 $\Omega$		0.2 - 3956 $\Omega$ -m	
	200 $\Omega$		20 - 39.56k $\Omega$ -m	
	2000 $\Omega$		0.2 - 395.6k $\Omega$ -m	
	20k $\Omega$		2.0 - 1999k $\Omega$ -m	
	200k $\Omega$			
Series interference voltage Ust (A.C only)	50V	0.1V	0 - 50.9Vrms	$\pm 2\% \pm 2dgt$
Frequency Fst	Autoranging	0.1Hz, 1Hz	40Hz - 500Hz	$\pm 1\% \pm 2dgt$
Test Current	80mA(max)			
Memory capacity	800 data			
Communication interface	Model 8212-USB Optical Adaptor			
LCD	Dot-matrix 192 $\times$ 64, monochrome			
Over-range indication	"OL"			
Overload protection	between E-S(P) and between E-H(C) terminals AC280V / 10 sec			
Applicable Standards	IEC 61010-1 CAT IV 150V, CAT III 300V Pollution degree 2 IEC 61557-1,5, IEC 61326-1(EMC), IEC 60529(IP54)			
Power source	DC12V : sizeAA manganese dry battery (R6) $\times$ 8 (Auto power off: approx. 5 minutes)			
Dimensions	167(L) $\times$ 185(W) $\times$ 89(D)mm			
Weight	approx. 900g (including batteries)			
Accessories	7229A(Earth resistance test leads), 7238A(Simplified measurement test leads) 8032(Auxiliary earth spikes[2spikes/set]) $\times$ 2, 8200-04(Cord reels [4pcs]), 8212-USB(USB adaptor with "KEW Report(Software)") 8923(Fuse [0.5/250V]) $\times$ 1 (included), 1 (spares) 9121(Shoulder strap), 9125(Carrying case) R6 $\times$ 8, Instruction manual			



## KEW 4300

SIMPLIFIED EARTH TESTER



4300	
Earth resistance ranges	200.0/2000 $\Omega$ (Auto ranging) $\pm 3\%rdg \pm 5dgt$
Voltage ranges	AC:5.0 - 300.0V(45 - 65Hz) $\pm 1\%rdg \pm 4dgt$ DC: $\pm 5.0$ - 300.0V $\pm 1\%rdg \pm 8dgt$
Applicable Standards	IEC 61010-1 CAT III 300V pollution degree 2 IEC 61557-1,-5 IEC 61326-1,2-2, IEC 60529(IP40)
Power source	LR6(AA)(1.5V) $\times$ 2
Dimensions	232(L) $\times$ 51(W) $\times$ 42(D)mm
Weight	220g approx(including battery)
Accessories	7248(Test lead with Alligator clip and Flat test probe) 8072(CAT II Standard prod) 8253(CAT III Standard prod) 8017(Extension prod long) 9161(Carrying case) Instruction manual, LR6(AA) $\times$ 2

KEW4300 is simplified earth resistance tester (based on 2-pole method) that can be used for various distribution lines and electrical appliances and it also can measure AC/DC voltage. (As for AC voltages, true rms values can be obtained.)

- 200/2000 $\Omega$  (2 ranges) : auto-ranging.
- Warning buzzer triggered at 100 $\Omega$  or less.
- LED lights up when a large earth voltage is detected.
- Live circuit warning when 30V or higher voltage is detected. (KEW4300 detects voltage even when measuring resistances.)
- LED light for illuminating measurement points. (It turns on/off automatically in relation to the ambient brightness.)
- Small test current (max 2mA) not triggering RCD.



# EARTH CLAMP TESTERS

## MODEL 4200/KEW 4202



photo : 4202



	4200	4202
Earth resistance	20.00/200.0/1500Ω	
Auto range	±1.5%±0.05Ω(0.00 - 20.99Ω)* ±2%±0.5Ω(16.0 - 99.9Ω) ±3%±2Ω(100.0 - 209.9Ω) ±5%±5Ω(160 - 399Ω) ±10%±10Ω(400 - 599Ω) Values are displayed, but accuracy isn't guaranteed(600 - 1580Ω)	
AC current (50Hz/60Hz)	100.0/1000mA/10.00/30.0A	
Auto range	±2%±0.7mA(0.0 - 104.9mA) ±2%(80mA - 31.5A)	
Operating indication	Earth resistance function : Constant voltage injection Current detection (Frequency : Approx.2400Hz) Dual Integration AC current function : Successive approximation	
Over-range indication	"OL" is displayed when input exceeds the upper limit of a measuring range	
Response time	Approx. 7 seconds (Earth resistance) Approx. 2 seconds (AC current)	
Sample rate	Approx. 1 times per second	
Communication Interface	—	Bluetooth® Ver2.1 + EDR Class2
Power source	LR6/R6(AA)(1.5V) × 4	
Current consumption	Approx. 50mA (max.100mA)	Approx. 50mA (max.100mA)
Measurement time	Approx.12 hours (when R6 is used) Approx.24 hours (when LR6 is used)	Approx.5 hours (when R6 is used) Approx.21 hours (when LR6 is used)
Auto power-off	Turns power off about 10 minutes after the last button operation.	
Applicable Standards	IEC 61010-1 CAT IV 300V Pollution degree2 IEC 61010-2-032, IEC 61326 (EMC)	
Conductor size	Approx. φ32mm	
Dimension	246(L) × 120(W) × 54(D)mm	
Weight	Approx. 780g (including batteries)	
Accessories	R6(AA) × 4, Instruction manual 8304 (Resister for operation check)	LR6(AA) × 4, Instruction manual 8304 (Resister for operation check) 9166 (Carrying case[Hard]) 9167 (Carrying case[Hard])

\*Crest factor ≤ 2.5 (50Hz/60Hz, peak value shall not exceed 60A)

\*4 counts or less are corrected to 0.

Note: A single earthing can not be measured. (Only for Multiple Earthing system)

- The earth resistance from 0.05 to 1500Ω can be measured without the auxiliary earth spikes in multi-earthing systems
- True RMS leakage or phase current readings from 0.1mA to 30.0A provides vital additional information in earthing networks
- Filter function offers increased immunity to electrical noise and a Noise mark appears in excessively high noisy environments
- Memory function up to 100 data
- Bluetooth® communication (4202 only)

Various useful functions are available on Android™ devices using Bluetooth® communication(4202 only)

Free Android software "KEW Smart 4202" is available on download site



※Communication charges may be incurred separately to download application

Recorded data can be transferred (up to 100 measurements)



Measured data with time and location info can be sent by E-mail

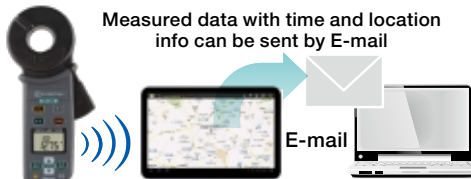

GPS data collection may be lost since the GPS signal differs depending on the location of satellites.  
To access GPS data and send emails, an Internet connection is required.  
Communication charges may be incurred separately for using these functions.

Comparator function informs when the measured value is lower/higher than the preset value



## Accessories

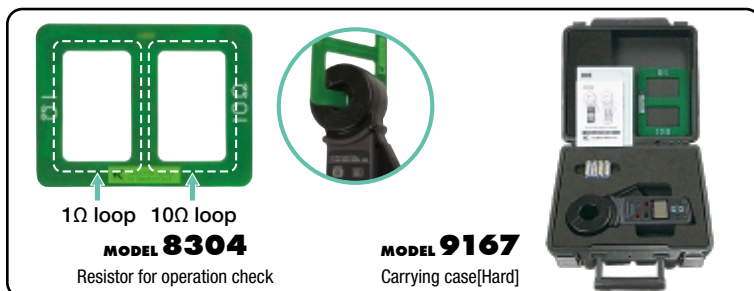

※ Available on the Android devices equipped with Bluetooth®/ GPS/ Data communication function.

Max communication distance :10m

Bluetooth® is a registered trademark of the Bluetooth SIG, Inc.

Android is a registered trademark of the Google Inc.

## Earth Clamp Line up

	4200	4202
Comon functions	Earth resistance, AC current, Back light function, Data hold function, Auto power off, Memory function	
Individual functions	—	Bluetooth® communication

# LOOP/PSC TESTERS

## MODEL 4118A



- Custom microprocessor controlled for highest accuracy and reliability.
- 3 LEDs for checking correct wiring status.
- 15mA LOOP measurement: LOOP impedance 2000Ω range measurement is carried out with low test current (15mA). The current will not cause tripping out involved RCD even the one with the lowest nominal differential current (30mA).
- Direct reading of Prospective Short Circuit Current (PSC).
- Measure low loop resistances (resolution of 0.01Ω)
- Automatic lock-out if test resistor overheats.
- Large custom digital display readout .
- Visual indication of reversed phase and neutral wiring at socket.
- Designed to IP54 Rating

	4118A
Loop impedance ranges	20/200/2000Ω
Loop impedance accuracy	±2%rdg±4dgt
AC test current	20Ω 25A 200Ω 2.3A 2000Ω 15mA
AC test period	20Ω (20ms) 200Ω (40ms) 2000Ω (280ms)
PSC ranges	200A(2.3A 40ms) 2000A(25A 20ms) 20kA(25A 20ms)
PSC ranges accuracy	Consider accuracy of loop impedance
Voltage	110V - 260V ±2%rdg±4dgt
Operating voltage	230V +10%, -15%(195V - 253V)50Hz
Applicable Standards	IEC 61010-1 CAT III 300V Pollution degree 2 IEC 61557-1,3, IEC 60529(IP54)
Dimensions	167(L) × 185(W) × 89(D)mm
Weight	750g approx.
Accessories	Molded plug test leads* 7121B(Distribution board test leads) 9147(Cord case) 9121(Shoulder strap) Instruction manual

\* 7123(AU): Australian plug 7124(UK): British plug(13A)  
7125(EU): European SCHUKO plug 7126(SA): South african plug

## Accessories



**MODEL 7121B**  
(Distribution board test leads)



### Molded plug test leads

- MODEL 7123** (AU) Australian plug
- MODEL 7124** (UK) British plug(13A)
- MODEL 7125** (EU) European SCHUKO plug
- MODEL 7126** (SA) South african plug

## Loop Testing Methods

In the buildings mainly used for private residence where low voltage power is supplied from electric utilities the fundamental protection against electric shock hazards is provided by appropriately coordinating the function of an earthing circuit with automatic switches placed at the latter stage of indoor wiring circuits. This is intended to quickly cut off the supply to an earthing circuit where a fault occurs following touch voltage exceeding an acceptable limit. Proper protection against electric shock hazards is given when the TT wiring system satisfies the requirement as expressed by the following formula:

$$R_a \times I_a \leq 50$$

where  $R_a$  is the sum of the resistances of earth bars and protective conductors and  $I_a$  is the maximum current of a protection system provided for installations, indicating that the value obtained by multiplying  $R_a$  with  $I_a$  is not more than 50V. This means a maximum voltage one can touch shall not exceed 50V in the event of an earth fault.

- Method of earth fault loop impedance testing at socket outlet. As shown in Fig., total earth fault loop impedance can be measured by plugging a loop tester into socket. The value of earth fault loop impedance measured represents the sum of transformer coil winding resistance, phase conductor (L3) resistance and protective conductor (PE) resistance as well as source earth resistance and installation earth resistance. With the loop tester set to any one of the PSC (prospective short circuit current) range, it is also possible to measure earth fault current.

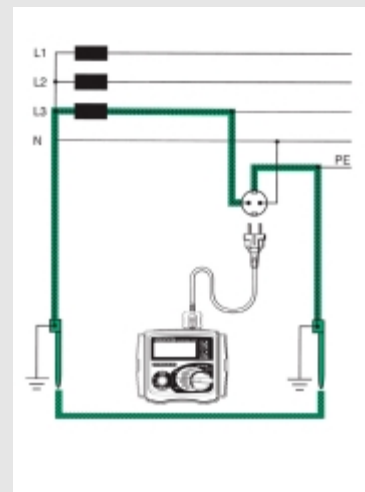

Fig. Earth fault loop impedance testing at socket outlet.





# LOOP/PSC TESTERS

## KEW 4140



- Anti-Trip Technology for complete trip free Loop testing on all RCDs rated 30mA and above.
- Dual Display allows simultaneous measurements like Loop & PFC/PSC.
- Two wire connection for Loop L-L, L-N and PSC testing is possible.
- Phase rotation, Voltage and Frequency measurements.
- Lock-down test button for 'hands free' testing with auto-start operation.
- Display and front panel keyboards with Backlight to be visible in dark places.
- Water and Dust proof (IP54)



4140			
<b>Loop Impedance</b>			
Function	L-PE ATT OFF	L-PE ATT ON	L-N/L-L
Rated voltage	230V (50/60Hz)		L-N: 230V (50/60Hz) L-L: 400V (50/60Hz)
Operating Voltage	100 - 280V (45 - 65Hz)		100 - 500V (45 - 65Hz)
Range (Auto-Ranging)	20/200/2000Ω	20/200/2000Ω (L-N<20Ω)	20Ω
Nominal Test Current at 0Ω External Loop: Magnitude/Duration at 230V	20Ω:6A/40ms 200Ω:2A/20ms 2000Ω:15mA/500ms	L-N:6A/60ms N-PE:10mA/approx. 5s	20Ω:6A/20ms
Accuracy	±3%rdg±4dgt (*1)	±3%rdg±6dgt (*1)	L-N: ±3%rdg±4dgt L-L: ±3%rdg±8dgt
<b>PFC(L-PE)/PSC(L-N/L-L) (*2)</b>			
Function	PSC/PFC	PSC/PFC (ATT)	PSC
Rated voltage	230V (50/60Hz)		L-N: 230V (50/60Hz) L-L: 400V (50/60Hz)
Operating Voltage	100 - 280V(45 - 65Hz)		100 - 500V(45 - 65Hz)
Range (Auto-Ranging)	2000A/20kA	2000A/20kA(L-N<20Ω)	2000A/20kA
Nominal Test Current at 0Ω External Loop: Magnitude/Duration at 230V	20Ω:6A/40ms 200Ω:2A/20ms 2000Ω:15mA/500ms	L-N:6A/60ms N-PE:10mA/approx. 5s	20Ω: 6A/20ms
<b>Phase Rotation</b>			
Operating Voltage	50 - 500V, 45 - 65Hz		
Remarks	Correct phase sequence : displayed "1.2.3" and ⌚ mark Reversed phase sequence : displayed "3.2.1" and ⌚ mark		
<b>Volts</b>			
Function	Volts		Frequency
Measuring range	0 - 500V		45 - 65Hz
Accuracy	±2%rdg±4dgt		±0.5%rdg±2dgt
Applicable Standards	IEC 61010-1 CAT III 300V (500V L to L) IEC 61557-1,3,7,10, IEC 60529 (IP54), IEC 61326(EMC)		
Power source	LR6/R6(AA)(1.5V) × 6 *Use of alkaline batteries (LR6) is recommended.		
Dimensions	84(L) × 184(W) × 133(D)mm		
Weight	860g (including batteries.)		
Accessories	Main test lead (*3), Distribution board test lead (*4), 9155 (shoulder strap), 9156A (Soft case) LR6 (AA) × 6, Instruction manual		

\*1: Accuracy of L-N LOOP displayed on the Sub Display is synchronized with the one at L-N/L-L function.

\*2: PSC/PFC Accuracy is derived from measured loop impedance specification and measured voltage specification.

\*3: 7187A:(UK)British plug, 7218A:(EU)European SCHUKO plug, 7221A:(SA)South african plug, 7222A: (AU)Australian plug

\*4: 7246 : Blue, Green, Red, 7247 : Black, Green, Red

## Accessories



**Main test lead**

**MODEL 7187A**

**MODEL 7218A** (EU)European SCHUKO plug

**MODEL 7221A** (SA)South african plug

**MODEL 7222A** (AU)Australian plug



**Distribution board test lead**

**MODEL 7246** Blue, Green, Red

**MODEL 7247** Black, Green, Red



**MODEL 9156A**

Soft case

# RCD TESTERS

## MODEL 5406A



- Custom microprocessor controlled for highest accuracy and reliability.
- 3 LEDs for checking correct wiring status.
- 0 and 180 degree phase angle switch permits quick tests and consistent readings.
- Digital read-out of tripping time.
- Test of a large kind of RCDs : Standard, Selective, AC and A(DC sensitive breakers).
- Constant current source circuitry ensures that a fluctuating mains voltage does not affect the accuracy of readings.
- Large custom digital display readout .
- Visual indication of reversed phase and neutral wiring at socket.
- Designed to IP54 Rating.
- Complies with IEC 61557

5406A	
Rated tripping current	10/20/30/200/300/500mA
Fault condition settings	× 1/2 × 1 × 5 × DC Auto Ramp
Trip current duration	1000ms 200ms(× 5)
Lowest resolution	1ms
Trip time accuracy	±0.6%rdg±4dgt
Operating voltage	230V+10%-15% (195V - 253V)[50Hz]
Applicable Standards	IEC 61557-1,6 IEC 61010-1 CAT III 300V IEC 61010-031 Pollution degree 2 IEC 60529(IP54)
Dimensions	167(L) × 186(W) × 89(D)mm
Weight	800g approx.
Accessories	Molded plug test leads*, 9147(Cord case) 9121(Shoulder strap), Instruction manual
Optional	7121B(Distribution board test leads)

\* 7123(AU) : Australian plug 7124(UK) : British plug(13A)  
7125(EU) : European SCHUKO plug 7126(SA) : South african plug

### Accessories

#### Molded plug test leads

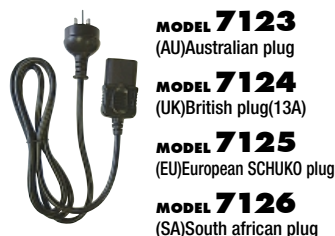

### Optional Accessory



## KEW 5410



- **Measurement of RCD trip time**  
Conducting testing of rated residual non-operating currents at × 1/2 Range, measuring RCD trip time at × 1 and × 5 Ranges.
- **Measurement of trip out current**  
Measuring trip out current by varying current automatically.
- **Remote Test**  
Enabling a user to hold the Test Leads with his both hands by locking the Test Button. Measurement will automatically start when the main voltage is detected.
- **Voltage Measurement**  
Carrying out a constant measurement of voltage in the stand-by mode at each Range.
- **Auto-detection of Contact voltage**  
Detecting the voltage to earth of Earth electrodes or Protective conductors during RCD test - when applying test currents - at measurement using EARTH in order to prevent electrical shocks caused by the damaged earth. Measurement will be ceased at AC50V or more.
- **Dust and Water proof**  
Dust and Water proof construction. (designed to IEC 60529 IP54)
- **Backlight**  
Facilitating working at dimly illuminated locations.

5410					
		Measurement of RCD trip time		Measurement of trip out current	
Range		× 5	× 1	× 1/2	Auto Ramp (mA)
Rated voltage		100V±10%, 200V+32%/-10%, 400V±10%, (50/60Hz)			
Test current		15/30/50/100mA	15/30/50/100/200/500mA	15/30/50/100/200/500mA	
Measuring range	Testing time	200ms	2000ms	2000ms	40% - 110% of IΔn (goes up by 5%) Testing time 300ms × 15 steps
	Test current	±1%rdg±3dgt	±1%rdg±3dgt	±1%rdg±3dgt	Test current at each step -4% - +4%
Voltage measurement					
Measuring range		80V - 450V(50/60Hz)			
Accuracy		±2%rdg±4dgt			
Applicable Standards		IEC 61010-1 Pollution degree 2 CAT III 300V/ CAT II 400V IEC 61557-1,6 IEC 60529(IP54)			
Operating temperature & humidity		0°C - 40°C, relative humidity 85%(no condensation)			
Storage temperature & humidity		-20°C - 60°C, relative humidity 85%(no condensation)			
Power source		R6(AA)(1.5V) × 8			
Dimensions		167(L) × 186(W) × 89(D)mm			
Weight		Approx. 965g (including batteries)			
Accessories		7128A(Test leads), 7129A(Test lead with alligator clip) 8017(Extension prod) × 2, 9147(Cord case), 9121(Shoulder strap), Instruction manual, R6(AA) × 8			

\*Only the RCD type G (without trip out time-delay) can be tested at Auto Ramp Test ; type S (time-delay) cannot be tested.

### Accessories



# PORTABLE APPLIANCE TESTER



# PORTABLE APPLIANCE TESTER

## KEW 6205

RMS USB



- Battery operated
- PASS/FAIL result
- Color status back light
- 10mA & 30mA RCD test (Isolation transformer built in)
- Memory function up to 999 data
- Printer output

\*KEW 6205 equipped with Wire-less LAN is available only in Australia and New Zealand.

The KEW 6205 is a hand-held portable appliance tester and can test electrical safety of Class I and Class II appliances. The Tester performs test and indicates PASS/FAIL result complying with the criteria of judgment defined in the AS/NZS 3760:2010 for In-service safety inspection and testing of electrical equipment.

## Test Function

Function	Tests of contents
Class I Test	<ul style="list-style-type: none"> <li>• Protective conductor resistance (Test current 200mA DC nominal)</li> <li>• Insulation resistance test (250V or 500V)</li> <li>• Leakage current test (100-253V/50Hz)</li> <li>• Load current test (100-253V/50Hz)</li> </ul>
Class II Test	<ul style="list-style-type: none"> <li>• Insulation resistance test (250V or 500V)</li> <li>• Leakage current test (100-253V/50Hz)</li> <li>• Load current test (100-253V/50Hz)</li> </ul>
Extension Lead Test	<ul style="list-style-type: none"> <li>• Protective conductor resistance (Test current 200mA DC nominal)</li> <li>• Insulation resistance test (between Line/Neutral-Earth short, Line/Neutral)</li> <li>• Leakage current test (100-253V/50Hz)</li> <li>• Polarity test</li> </ul>
RCD Test	<ul style="list-style-type: none"> <li>• RCD test (10mA/30mA)</li> </ul>

## Accessories

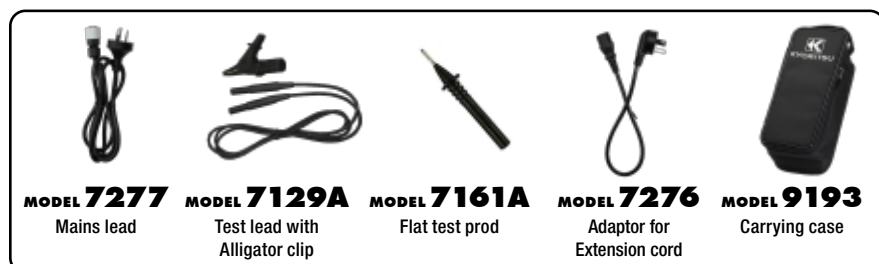

## Optional Accessories



6205	
Mains voltage indication	
Display range	30V-270V
Accuracy	±5V
Protective conductor resistance test	
Measuring range	0.00-20.00Ω
Open circuit voltage	5V±0.4V DC
Measuring current	200mA DC(nominal value)
Accuracy	±3%rdg±5dgt
Insulation resistance test	
Rated voltage	250V 500V
Measuring range	0.00-20.00MΩ
No-load voltage	250V DC +20%,-0% 500V DC +20%,-0%
Short circuit current	1.5mA DC or less
Accuracy	±2%rdg±3dgt
Load current/Leakage current test	
Item	Load current Leakage current
Mains voltage range	100-253V/50Hz
Measuring range	0.10-10.00A rms 0.10-20.00mA rms
Accuracy	±10%rdg±5dgt ±3%rdg±5dgt
RCD test	
Rated voltage	230V -15% - +10%/50Hz
Rated current	10mA/30mA
Function	× 1 × 5
Test duration	0.0ms-500.0ms 0.0ms-40.0ms
Operating time accuracy	±2ms(≤ 40ms), ±8ms(>40ms)
Power source	LR6(AA)(1.5V) × 6
Applicable Standards	IEC 61010-1 CAT II 300V, IEC 61010-2-030, IEC 61010-031, EN 61326-2-2, AS / NZS3760
Dimensions	261(L) × 104(W) × 57(D)mm
Weight	Approx. 930g(including batteries)
Accessories	7277(Mains lead), 7129A(Test lead with Alligator clip), 7161A(Flat test prod), 7276(Adaptor for Extension cord), 9193(Carrying case), 8928(Fuse[10A/250V]), 9121(Shoulder strap), Buckle, LR6(AA) × 6, Instruction manual
Optional	8263-USB (USB cable with "KEW Report(software)"), 7275(Printer cable:Mini Din 6pin - D-sub 9pin) 7248(Test lead with Alligator clip and Flat test probe)

## Color status back light

PASS / FAIL result complying with AS/NZS 3760



PASS



FAIL



# MULTI FUNCTION TESTERS



# MULTI FUNCTION TESTERS

Video



## KEW 6516/6516BT

6516BT  
Bluetooth



12 in 1

<b>Insulation</b> 100/250/500/1000V	<b>Loop</b> 2/20/200/2000Ω	<b>RCD</b> 10/30/100/300/500/1000mA
<b>PSC</b> 2000A/20kA	<b>PFC</b> 2000A/20kA 2000A/50kA	<b>Earth</b> 20/200/2000Ω
<b>ACV</b> 300V/600V	<b>Continuity</b> 20/200/2000Ω	<b>Phase rotation</b>
<b>Frequency</b>	<b>SPD(Varistor)</b>	<b>PAT</b>



photo : 6516BT

### Insulation

- 4 ranges available for insulation resistance test(100/250/500/1000V) Automatic discharge of circuit capacitance.
- Polarization Index(PI) and Dielectric Absorption Ratio (DAR).

### Loop

- High test current range of 2Ω with 0.001Ω resolution.
- Zs Limit compares the values required by Electrical Installations Standard with measured results.

### RCD

- Type AC, A, F, B(General & Selective), EV (Electric Vehicle) and Variable RCDs.
- Single and Auto test, Ramp test and Contact voltage.

### Earth

- Earth resistance test 2 and 3 wires with all accessories included.

### ACV

- TRMS Voltage measurements 2-600V, Mains Frequency.

### Continuity

- Continuity test at 200mA or 15mA with selectable buzzer for fast judgment.

### Phase rotation

- On 3-phase lines with clear indication of the sequence on the display.

### SPD (Varistor)

- Surge Protective Device test, for SPD that uses varistor.

### PAT

- Portable Appliance Tester function, for Insulation and Continuity.

### Display

- Color LCD 3.5 inches dot matrix.

### ATT

- Anti-Trip Technology (with 2 & 3 wire) for no trip LOOP L-PE testing on all RCDs.
- With 2 wire only, very useful in case of no Neutral (e.g. 3-phase motor lines).

### HELP

- Display shows how to connect the instrument according to the function selected.

### Memory

- Save and display up to 1000 data.

### Bluetooth

- Communication by "KEW Connect" (6516BT only).

### Safety

- IEC 61010-1 CAT IV 300V, CAT III 600V. IEC 61557-1,2,3,4,5,6,7,10.

## Accessories



Main test lead



7187A

7221A

7218A

7222A

Plug

**MODEL 7281**  
Remote test lead



**MODEL 7246**  
Distribution board test leads



**MODEL 7228A**  
Earth tests leads



**MODEL 8041**  
Auxiliary earth spikes  
(2 spikes/set)



**MODEL 8212-USB**  
Model 8212USB with PC Software  
"KEW Report" (Standard accessory for  
KEW 6516, optional for KEW 6516BT)



**MODEL 9151**  
Shoulder strap

**MODEL 9199**  
Shoulder pad



**MODEL 9084**  
Soft case



**MODEL 9142**  
Carrying case



MULTI FUNCTION TESTERS

# MULTI FUNCTION TESTERS

## 6516/6516BT

Insulation resistance		SPD(Varistor)					
Test voltage	100V	250V	500V	1000V	Max.1000V		
Measuring ranges	2.000/20.00/200.0MΩ (Auto-ranging)		20.00/200.0/1000MΩ (Auto-ranging)	20.00/200.0/2000MΩ (Auto-ranging)		0-1000V(goes up by 1V)	
Accuracy	±2%rdg±6dgt (2.000/20.00MΩ) ±5%rdg±6dgt (200.0MΩ)		±2%rdg±6dgt (20.00/200.0MΩ) ±5%rdg±6dgt (1000MΩ)	±2%rdg±6dgt (20.00/200.0MΩ) ±5%rdg±6dgt (2000MΩ)		±5%rdg±5dgt	
Rated current	1.0-1.2mA @0.1MΩ	1.0-1.2mA @0.25MΩ	1.0-1.2mA @0.5MΩ	1.0-1.2mA @1MΩ		-	
Output short circuit current	1.5mA max					-	
Loop impedance							
Function	LOOP ATT		LOOP HIGH				
	L-PE/L-N(3wire)		L-PE(2wire)	L-PE(0.01ΩRes)	L-PE(0.001ΩRes)	L-N/L-L	
Rated voltage	100-260V(50/60Hz)		48-260V(50/60Hz)	48-260V(50/60Hz)	100-260V(50/60Hz)	48-500V(50/60Hz)	
Impedance range	20.00/200.0/2000Ω (Auto-ranging)		20.00/200.0/2000Ω (Auto-ranging)	2.000Ω		20.00Ω	
Accuracy	±3%rdg±6dgt		±3%rdg±10dgt	±3%rdg±4dgt	±3%rdg±25mΩ	±3%rdg±4dgt	
Nominal test current at 0Ω external loop: Magnitude/Duration at 230V	L-N:6A/60ms N-PE:10mA		L-PE:15mA	20Ω:6A/20ms 200Ω:0.5A/20ms 2000Ω:15mA/500ms	25A/20ms	6A/20ms	
PSC/PFC							
Range	2000A/20kA(PSC/PFC)		2000A/20kA(PFC)	2000A/20kA(PFC)	2000A/50kA(PFC)	2000A/20kA(PSC)	
Accuracy	PSC/PFC accuracy is derived from measured loop impedance specification and measured voltage specification						
RCD							
Rated voltage	100-260V(50/60Hz)						
Function	x1/2, x1_x5,Ramp,Auto,Uc						
	10/30/100/300/500/1000mA/variable						
RCD type	AC(G/S)		A(G/S)	F(G/S)	B(G/S)	EV	
Trip current setting	x1/2,x1,Uc	10/30/100/300/500/1000mA(G) 10/30/100/300/500(S)	10/30/100/300/500mA	10/30/100/300/500mA	10/30/100/300mA	6mA (x1 only)	
	x5	10/30/100mA	10/30/100mA	10/30/100mA	10/30mA	-	
	Ramp	10/30/100/300/500mA	10/30/100/300/500mA	10/30/100/300/500mA	10/30/100/300mA	6mA	
Accuracy	Trip current	x1/2	-8% - -2%	-10% - 0%	-10% - 0%	-10% - 0%	-
		x1	+2% - +8%	0% - +10%	0% - +10%	0% - +10%	0% - +10%
		x5	+2% - +8%	0% - +10%	0% - +10%	0% - +10%	-
		Ramp	-4% - +4%	-10% - +10%	-10% - +10%	-10% - +10%	-10% - +10%
	Trip time	x1/2	2000ms(G/S):±1%rdg±2ms				-
	x1	550ms(G):±1%rdg±2ms,1000ms(S):±1%rdg±2ms				10.5s:±1%rdg±2ms	
	x5	410ms(G/S):±1%rdg±2ms				-	
Continuity							
Range	20.00/200.0/2000Ω (Auto-ranging)						
Open circuit voltage (DC)	7-14V						
Measuring current	200mA	>200mA					
	15mA	15mA±3mA					
Accuracy	±2%rdg±8dgt						
Phase Rotation							
Rated voltage	48-600V(50/60Hz)						
Remarks	Remarks Correct phase sequence: are displayed "1.2.3" and mark Reversed phase sequence: are displayed "3.2.1" and mark						
Earth							
Range	20.00/200.0/2000Ω(Auto-ranging)						
Accuracy	Volts		±2%rdg±0.08Ω(20.00Ω)				
	Frequency		±2%rdg±3dgt(200.0/2000Ω)				
General							
Applicable Standards	IEC 61010-1 CAT IV 300V,CAT III 600V Pollution degree 2, IEC 61010-2-034, IEC 61557-1,2,3,4,5,6,7,10, IEC 60529(IP40), IEC 61326(EMC)						
Communication Interface	USB, Bluetooth® 5.0 *1, Android™ 5.0 or more, iOS 10.0 or more						
Power source	LR6 × 8						
Dimensions	136(L) × 235(W) × 114(D)mm						
Weight	1350g (including batteries.)						
Accessories	Main test lead*2, 7281(Test leads with remote control switch), 7246(Distribution board test lead), 7228A(Earth resistance test leads), 8041(Auxiliary earth spikes[2 spikes/set]) 9084(Soft case), 9142(Carrying case), 9151(Shoulder strap), 9199(Shoulder pad), Battery, Instruction manual, 8212-USB(USB adaptor with "KEW Report(Software)")*3						
Optional	8212-USB(USB adaptor with "KEW Report(Software)")*3, 8259(Adapter for measurement terminal), 7272(Precision measurement Cord set), 8017A(Extension prod long)						

\*1 6516BT only

Some countries regulate the compliance with their Radio Law of the products equipped with Bluetooth®. Please confirm it with your distributor before purchasing our products equipped with Bluetooth®.

\*2 7187A:British plug, 7218A:(EU)European SCHUKO plug, 7221A(SA) South african plug, 7222A:(AU)Australian plug

\*3 8212-USB : Standard accessory for 6516, optional accessory for 6516BT

### Optional Accessories

**MODEL 7272**  
Precision measurement cord set



MODEL 7267 Cable reel for Earth resistance tester (Red: 20m)

MODEL 7268 Cable reel for Earth resistance tester (Yellow: 10m)

MODEL 7271 Earth resistance test lead (Green 5m)

MODEL 8041 Auxiliary earth spikes[2 spikes/1set]

MODEL 9192 Carrying case for cord reels





**MODEL 8017A**  
Extension prod long

**MODEL 8259**  
Adapter for measurement terminal [red, yellow, green/1 set]

### Communication interface

**USB**



**KEW Report**

**Bluetooth®**



**KEW Smart Advanced**

Please search "KEW Smart"  
Communication charge may be incurred separately to download application.

# MULTI FUNCTION TESTERS

## KEW 6010B



- Designed to IEC 61010-1, IEC 61557
- Data Memory : 300 measured results
- Download Results to PC by Using 8212 Data Communication Adaptor through Optical RS-232C Port.

### 5 in 1

#### Continuity

20/200Ω

#### Loop

20/2000Ω

#### Uc

100V

#### Insulation

500/1000V

#### RCD

10/30/100/300/500mA

## Accessories



**MODEL 7122B**  
Test leads



**KAMP10**  
Test lead with IEC connector

## Optional Accessories



**MODEL 7133B**  
Distribution board test leads



**MODEL 8212-USB**  
USB adaptor with "KEW Report (Software)"

### "KEW Report" Software for report

"KEW Report" transfers measurement data from the KEW6010B to a PC via MODEL8212-USB



### Specifications

	<b>MODEL 8212-USB</b>
Communication method	USB Ver1.1
Driver type	Virtual COM port
Communication speed	19200bps max.
Dimensions	Adaptor : 53(L) × 36(W) × 19(D)mm Cable : 2m approx.
Operating temperature and humidity	-10 - +50°C 85%RH or less with no condensation
Storage temperature and humidity	-20 - +60°C 85%RH or less with no condensation

### System requirements

OS: Windows® 11/10/8.1/8  
Display: XGA (Resolution 1024 × 768 dots) or more  
Hard-disk: Space required 20Mbyte or more  
Others: With CD-ROM drive and USB port

\* Windows® is a registered trademark of Microsoft in the United States.

		<b>6010B</b>
<b>Continuity testing</b>		
Measuring range		20/200Ω (Auto-ranging)
Open circuit voltage		>6V
Short circuit current		>200mA
Accuracy		±3%rdg±3dgt
<b>Insulation testing</b>		
Measuring range		20/200MΩ(Auto-ranging)
Test voltage		500/1000V
Open circuit voltage		+20%, -0%
Rated current		>1mA
Accuracy		±3%rdg±3dgt
<b>LOOP Impedance testing</b>		
Impedance range		20Ω/2000Ω
Rated voltage		230V +10%, -15% [50Hz]
Normal test current		20Ω: 25A/10ms 2000Ω: 15mA/350ms max.
Accuracy		±3%rdg±8dgt
<b>RCD testing</b>		
Test current (Test current duration)	× 1/2, × 1	10, 30, 100, 300, 500mA (2000ms)
	FAST	150mA(50ms)
	DC	10,30,100,300mA (2000ms), 500mA(200ms)
	Auto ramp	Goes up by 10% from 20% to 110% of IΔn. 300ms × 10
Rated voltage		230V+10%, -15% 50Hz
Accuracy	Test current	× 1/2 : -8%, -2% × 1, Fast : +2%, +8%
	Trip time	DC : ±10% Auto ramp: ±4%
		±1%rdg±3dgt
<b>Uc testing</b>		
Measuring range		100V
Rated voltage		230V +10%, -15% [50Hz]
Test current		5mA at IΔn=10mA
		15mA at IΔn=30/100mA
		150mA at IΔn=300/500mA
Accuracy		+5% to +15%rdg±8dgt
<b>General</b>		
Applicable Standards		IEC 61010-1 CAT III 300V Pollution degree 2 IEC 61557-1,2,3,4,6,10, IEC 60529 (IP40)
Power source		R6 or LR6 × 8
Dimensions		115(L) × 175(W) × 86(D) mm
Weight		840g approx.
Accessories		7122B (Test leads) KAMP10 (Test lead with IEC connector)*
		8923 (Fuse[0.5A/250V] × 1 (included), 1 (spares)
		9092 (Cord case) 9121 (Shoulder strap) Shoulder pad
		Instruction manual R6(AA) × 8
Optional		7133B (Distribution board test leads)
		8212-USB (USB adaptor with "KEW Report (Software)")

\* KAMP10(EU):European SCHUKO plug KAMP10(UK):British plug(13A)  
KAMP10 (AU):Australian plug KAMP10(SA):South african plug





# MULTI FUNCTION TESTERS

## MODEL 6011A



CE

The Model 6011A can perform FIVE separate test functions: insulation, continuity, earth loop impedance, prospective short circuit current and RCD trip testing in full compliance with IEC 61557.

### 5 in 1

#### Continuity

20/200/2000Ω

#### Loop

20/200/2000Ω

#### PSC

200/2000/20kA

#### Insulation

250/500/1000V

#### RCD

10/30/100/300/500/1000mA

	6011A
<b>Continuity testing</b>	
Measuring ranges	20/200/2000Ω(Autoranging)
Open circuit voltage	>6V
Short circuit current	>200mA DC
Accuracy	±1.5%rdg±3dgt
<b>Insulation testing</b>	
Measuring ranges	20/200MΩ(Autoranging)
Test voltage	250/500/1000V DC
Output voltage on open circuit	250V+40%, -0%
	500+30%, -0% 1000V+20%, -0%
Rated current	> 1mA
Accuracy	±1.5%rdg±3dgt
<b>Loop impedance testing</b>	
Rated voltage	230V AC +10%, -15%[50Hz]
Voltage measuring range	100 - 250V AC[50Hz]
Impedance ranges	20/200/2000Ω
Nominal test current	25A(20Ω range) 15mA(200Ω range) 15mA(2000Ω range)
Accuracy	20Ω range ±3%rdg±4dgt 200Ω range ±3%rdg±8dgt 2000Ω range ±3%rdg±4dgt
<b>PSC testing</b>	
Rated voltage	230V AC +10%, -15%[50Hz]
PSC ranges	200A(15mA Test current) 2000A(25A Test current) 20kA(25A Test current)
Accuracy	PSC accuracy derived from measured loop impedance specification and measured voltage specification
<b>RCD testing</b>	
Rated voltage	230V AC +10%, -15%[50Hz]
Trip current settings	RCD × 1/2 :10,30,100,300,500,1000mA RCD × 1 : 10,30,100,300,500,1000mA RCD × 5 : 10,30,100,300mA (on × 5 range max current 1A)
Trip current duration	RCD × 1/2 × 1 : 2000ms RCD fast : 50ms
Accuracy	Trip current +10% -0% of test current at 230V Trip time ±1%rdg±3dgt
<b>General</b>	
Applicable Standards	IEC 61010-1 CAT III 300V pollution degree 2 IEC 61557 IEC 60529(IP54)
Power source	R6 or LR6 × 8
Dimensions	130(L) × 183(W) × 100(D)mm
Weight	1100g approx.
Accessories	KAMP10(Test lead with IEC connector)* 7122B(Test leads), 7132A(KSLP5)(External earth probe) 8923 (Fuse)0.5A/250V × 1 (included), 1 (spares) 9092(Cord case), 9121(Shoulder strap) R6(AA) × 8, Instruction manual
Optional	7133B(Distribution board test leads)

\* KAMP10(EU): European SCHUKO plug KAMP10(UK):British plug(13A)  
KAMP10(AU):Australian plug KAMP10(SA):South african plug

## MODEL 6018



CE



### 3 in 1

#### Insulation

250/500/1000V

#### ACV

600V

#### Earth

2/3 POLE 12/1201200Ω

	6018
<b>Insulation testing</b>	
Test voltage	250V/50MΩ 500V/100MΩ 1000V/200MΩ
Accuracy	±5%rdg
<b>Earth resistance</b>	
Simplified precision measurement	12Ω/120Ω/1200Ω
Accuracy	±3% of full scale value
<b>AC voltage</b>	
0 - 600V AC	±3% of full scale value
<b>Earth voltage</b>	
0 - 60V AC	±3% of full scale value
<b>General</b>	
Applicable Standards	IEC 61010-1 CAT III 600V pollution degree 2 IEC 61010-031 IEC 61557
Power source	R6(AA) × 8
Dimensions	130(L) × 183(W) × 100(D)mm
Weight	1000g approx.(including batteries)
Accessories	7103A(Test leads with remote control switch) 7161A(Flat test prod) 7131B(Safety crocodile clips [black]) 8017(Extension prod) 9092(Cord case) 9121(Shoulder strap) R6(AA) × 8 Instruction manual
Optional	7150A(Test leads with remote control switch set) 7245A(Precision measurement cord set) 8016(Hook type prod)

# PV INSULATION EARTH TESTER

## KEW 6024PV



- Accurate measuring of Insulation resistance even if the PhotoVoltaic (PV) arrays are generating power.
- No need to short circuit the PV arrays or test at night to measure the Insulation resistance.
- Earth resistance measurements with VoltAmperometric method at 3 and 2 pole.
- Waterproof design: Can measure in bad weather conditions.
- Memory function up to 1000 data.
- Luminescence buttons and large Backlight display.
- Elapsed time, after starting a measurement, is displayed with the measured values.
- Compact and light weight.
- Test probe with a remote control switch is supplied as standard accessory.
- Auto-discharge with voltage display and the measured value.
- Data transfer and analysis to a PC is possible by using its relative software included in the set.



**PV Insulation**  
500/1000V

**Insulation**  
250/500/1000V

**Earth**  
20/200/2000Ω

**Volts**  
AC 600V/DC 1000V

- Indication of test duration facilitates insulation integrity check with one-minute readings.

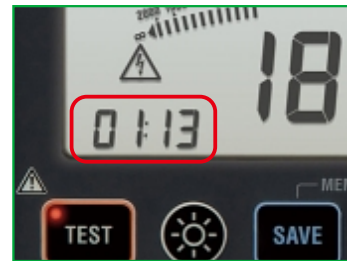

PV INSULATION EARTH TESTER

	6024PV				
Insulation resistance	PV Insulation*		Insulation		
Test voltage	500V	1000V	250V	500V	1000V
Measuring range (Auto range)	20.00/200.0/2000MΩ		20.00/200.0/2000MΩ		
Mid-scale value	-		50MΩ		
Rated current	-		1.0 - 1.2mA		
First effective measuring range	1.51 - 200.0MΩ	1.51 - 1000MΩ	1.51 - 100.0MΩ	1.51 - 200.0MΩ	1.51 - 1000MΩ
Accuracy	±1.5%rdg±5dgt		±1.5%rdg±5dgt		
Second effective measuring range	0.00 - 1.50MΩ	0.00 - 1.50MΩ	1.20 - 1.50MΩ	1.20 - 1.50MΩ	1.20 - 1.50MΩ
Accuracy	±5.0%rdg±6dgt		±5.0%rdg±6dgt		
Open circuit voltage	0 - +20%				
Short circuit current	Max 1.5mA				
Earth resistance					
Measuring range(Auto range)	20.00/200.0/2000Ω				
Accuracy	±3.0%rdg±0.1Ω (20Ω range) ±3.0%rdg±3dgt (200/2000Ω range)				
Voltage measurement					
Measuring range	AC 5 - 600V (45 - 65Hz) DC ±5 - 1000V				
Accuracy	±1.0%rdg±4dgt				
General					
Applicable Standards	IEC 61010-1 CAT IV 300V, CAT III 600V Pollution2 IEC 61010-2-030, IEC 61010-031, IEC 60529(IP54), IEC 61557-1,-2,-5,-10, IEC 61326-1,2-2				
Power source	LR6(AA)(1.5V) × 6				
Dimensions	84(L) × 184(W) × 133(D)mm				
Weight	Approx. 900g (including batteries)				
Accessories	7196B(Test leads with remote control switch), 7244A(Test lead with alligator clip), 8017(Extension prod long), 8072(CAT II Standard prod), 8212-USB(USB adaptor with "KEW Report(Software)"), 9155(shoulder strap), 9156A(Soft case), LR6(AA) × 6, Instruction manual				
Optional	7243A(L-shaped probe), 7245A(Precision measurement cord set), 8016(Hook type prod)				

\*6024PV supports the PV systems up to 1000V.



# PV INSULATION EARTH TESTER

## Accurate measurements not influenced by the generating PV voltage

### With conventional insulation testers:

[measurement needs to short - circuit the PV arrays]

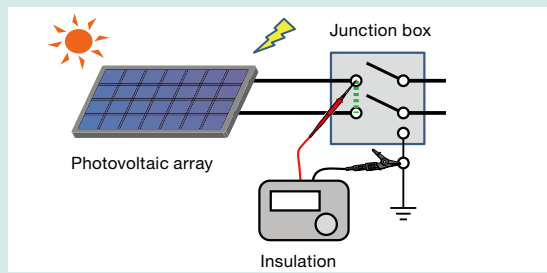

A breaker is required and risk of arc hazard exists.

[measurement without short - circuit the PV arrays]

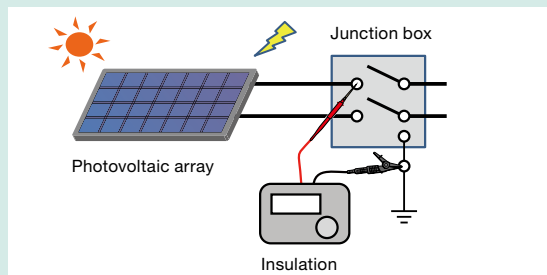

Low-risk, but not accurate.

### KEW 6024PV makes safe & accurate insulation resistance measurement possible!

- Increase your efficiency at work: no need waiting for the dark or compromising the accuracy of measurement.
- Safe: no need to short circuit the PV arrays.

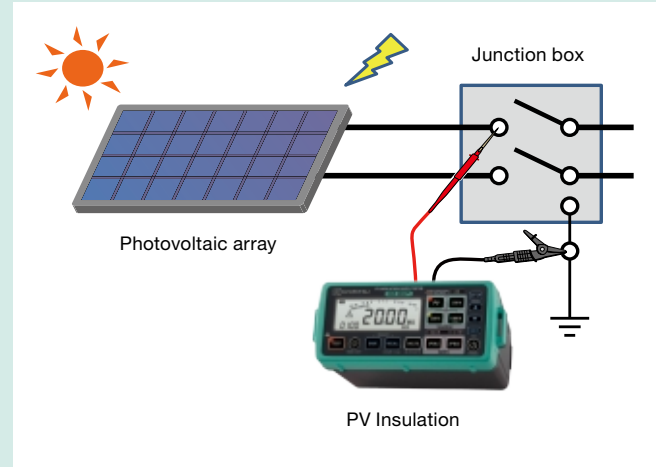

### Accurate and quick results also in case of large capacitance effects.

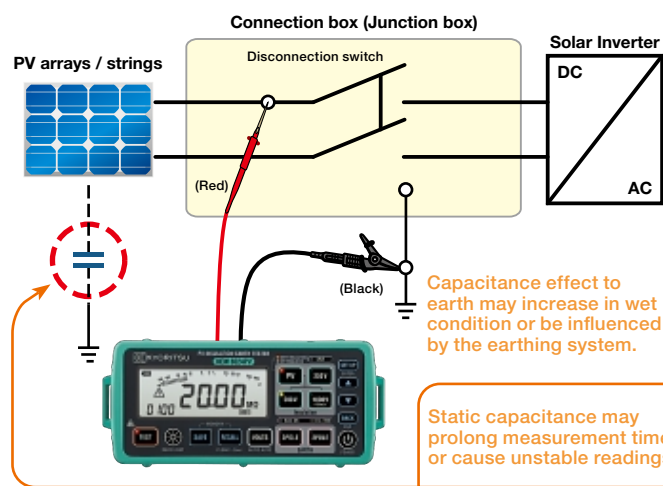

### Analyzing and processing the recorded data with a PC.

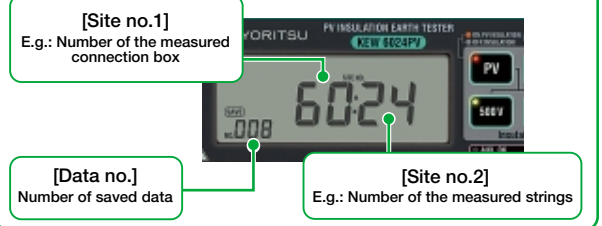

Can measure under the bad weather condition.

## Accessories

**MODEL 7196B**  
Test leads with remote control switch

**MODEL 7244A**  
Test lead with alligator clip

**MODEL 9156A**  
Soft Case

**MODEL 8017**  
Extension prod long

**MODEL 8072**  
CAT II Standard prod

**MODEL 8212-USB**  
USB adaptor with "KEW Report (Software)"

## Optional Accessories

**MODEL 7243A**  
L-shaped probe

**MODEL 7245A**  
Precision measurement cord set

**MODEL 8016**  
Hook type prod

# POWER METERS

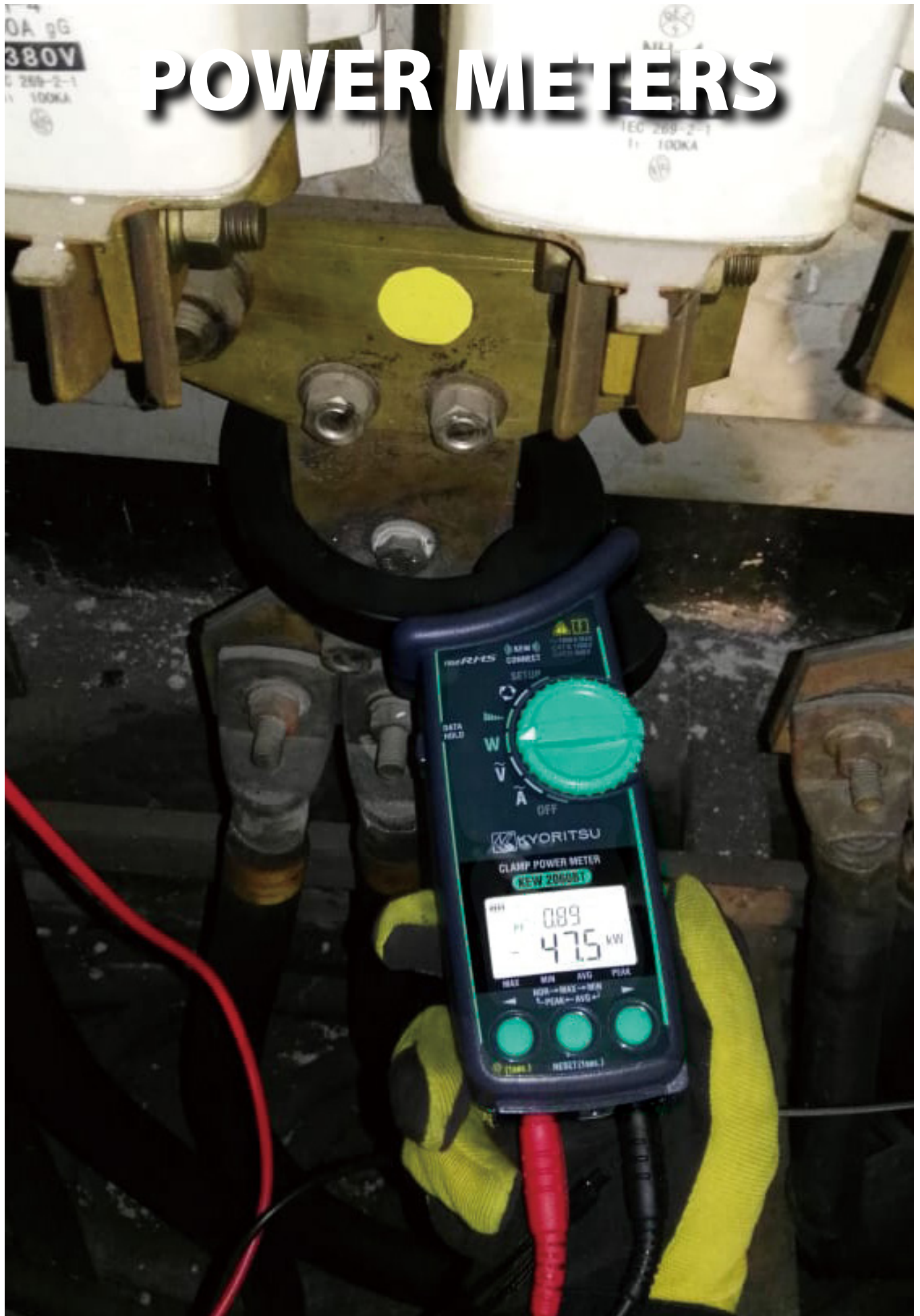

POWER METERS



# CLAMP POWER METERS



## KEW 2060BT/2062/2062BT

- Current up to 1000A rms
- Voltage up to 1000V rms
- Harmonics up to 30th

### Jaw shape with emphasis on the safety and the usability

- KEW 2060BT has a newly designed special jaw shape for using at a large busbar. Extremely large jaw with tear drop shape can clamp a large busbar with safe. (Conductor size 75mm, Busbar 80mm x 30mm)
- KEW 2062 and KEW 2062BT have a tear drop shape jaw, and the size is convenient to use at a small-sized office and factory. (Conductor size 55mm)



Wireless communication with smartphone or tablet (Except for 2062)



photo : 2060BT



photo : 2062



photo : 2062BT

	2060BT	2062/2062BT
Wiring connections	1P2W, 1P3W, 3P3W, 3P4W	
Measurements and parameters	Voltage, Current, Frequency, Active power, Reactive power, Apparent power, Power factor (cos φ), Phase angle, Harmonics (THD-R/THD-F), Phase rotation	
ACV		
Range	1000V	
Accuracy	±0.7%rdg±3dgt(40.0 - 70.0Hz) ±3.0%rdg±5dgt(70.1 - 1kHz)	
Crest factor	1.7 or less	
ACA		
Range	40.00/400.0/1000A (3 range auto)	
Accuracy	±1.0%rdg±3dgt (40.0 - 70.0Hz) ±2.0%rdg±5dgt (70.1 - 1kHz)	
Crest factor	3 or less on 40.00A/400.0A range, 3 or less 1500A peak on 1000A range	
Frequency		
Display range	40.0-999.9Hz	
Accuracy	±0.3%rdg±3dgt	
Active power		
Range	40.00/400.0/1000kW	
Accuracy	±1.7%rdg±5dgt (PF1, sine wave, 45-65Hz)	
Apparent power		
Range	40.00/400.0/1000kVA	
Accuracy	±1dgt against each calculated value Sum: add errors of each channel, 3P3W: ±2dgt, 3P4W: ±3dgt	
Reactive power		
Range	40.00/400.0/1000kVar	
Accuracy	±1dgt against each calculated value Sum: add errors of each channel, 3P3W: ±2dgt, 3P4W: ±3dgt	
Power factor		
Display range	-1.000 - 0.000 - +1.000	
Accuracy	±1dgt against each calculated value Sum: add errors of each channel, 3P3W: ±2dgt, 3P4W: ±3dgt	
Phase angle (1P2W only)		
Display range	-180.0 - 0.0 - +179.9	
Accuracy	±3.0°	
Harmonics RMS (Content rate)		
Analysis order	1st - 30th order	
Accuracy	±5.0%rdg±10dgt (1 - 10th) ±10%rdg±10dgt (11 - 20th) ±20%rdg±10dgt (21 - 30th)	
Total harmonics THD-R/THD-F		
Display range	0.0% - 100.0%	
Accuracy	±1 against the calculated results of each measured value.	
Phase rotation	ACV 80 - 1100V (45 - 65Hz)	
Other functions	MAX/MIN/AVG/PEAK, Data hold, Bluetooth® (Except for 2062), Back light, Auto power off	
General		
Communication interface	Bluetooth®5.0*, Android™5.0 or more, iOS 10.0 or more (Except for 2062)	
Power source	LR6(AAA)(1.5V) ×2	
Continuous measuring time	Approx. 58 hours	
Conductor size	φ75mm max. (busbar 80×30mm) φ55mm max.	
Dimensions / Weight	283(L)×143(W)×49(D)mm / approx. 590g (including batteries) 247(L)×105(W)×49(D)mm / approx. 490g (including batteries)	
Applicable Standards	IEC 61010-1, IEC 61010-2-032, IEC 61326-1,-2-2 ClassB CAT IV 600V / CAT III 1000V Pollution degree 2 CAT IV 300V / CAT III 600V / CAT II 1000V Pollution degree 2	
Accessories	7290 (Voltage test lead set) 9198 (Carrying case) LR6(AAA)×2, Instruction Manual	

\* Some countries regulate the compliance with their Radio Law of the products equipped with Bluetooth®. Please confirm it with your distributor before purchasing our products equipped with Bluetooth®. Bluetooth® is a trademark or registered trademark of Bluetooth SIG, Inc. Android™ is a trademark or registered trademark of Google Inc. iOS is a trademark or registered trademark of Cisco Technology, Inc. in the United States and other countries.

### Power measurement on any wiring system is possible.

KEW 2060BT, KEW 2062 and KEW 2062BT can perform 1P2W measurement and balance and unbalance measurements of 3P3W / 3P4W. The double display can simultaneously show many parameters like W & PF, W & deg, W & VA, W & Var, V & A, etc.

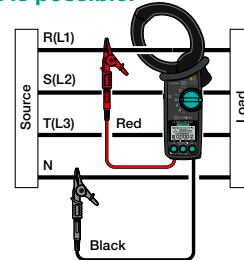

\* E.g.: 3P4W(Balance)

### Use the application KEW Power\* to improve work efficiency (Except for 2062)



#### Display image

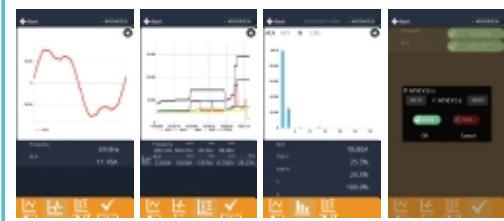

Download and install our special application "KEW Power\*" in your smartphone or tablet device for logging the measured values. Remote monitoring of voltage, current, power, trend graph of harmonics, and wave form is possible with "KEW Power\*"; this is helpful for simple Power Quality check. Measured values can be saved in your smartphone or tablet device in csv format: the data is editable in excel format.

### Accessories



MODEL 7290

MODEL 9198



## KEW 6305

RMS USB Bluetooth External Power Supply



- Comprehensive real-time monitoring, recording and analysis of single and 3-phase systems
- Voltage, Current, Power Factor and Frequency measurements
- Power analysis (Active, Apparent and Reactive power)
- Energy analysis (Active, Apparent and Reactive energy)
- Active power accuracy:  $\pm 0.3\%rdg \pm 0.2\%f.s.$
- Automatic wiring check function to prevent incorrect connections
- Large memory capability (2 GB) using built-in SD card Interface
- Recording interval can be set between 1second and 1hour.
- Real time & remote measurements using Android application
- Windows software for data analysis and setting via USB port or Bluetooth®
- Synchronous measurements between two units of KEW6305
- Wide selection of clamp sensors allow measurements from 0.1A to 3000A
- The instrument automatically recognizes what kind of clamp sensor is connected to it
- Double power supply system via AC line and batteries

### As easy as 1 → 2 → 3 !

Starting from OFF position and rotating the Rotary switch clockwise, KEW6305 is ready to use in 3 simple steps

#### 1. SET UP

Rotate the Rotary switch to SET UP. All the instrument settings can be easily selected by using instrument buttons. All the settings can also be selected by connecting KEW6305 to a PC via USB or Bluetooth®.

#### 2. WIRING CHECK

Rotate the Rotary switch to WIRING CHECK. The Automatic Wiring check function will prevent incorrect connections, check the connections and display the results on the LCD. Error messages appear on display to indicate wrong orientation of Clamp sensors or incorrect connections.

Everything is OK

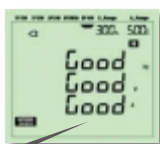

Shows "Good"

Error is found

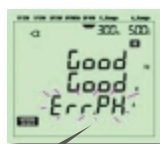

Shows "Err" (Error) e.g.: Err PH A  
→ Current phase (orientation of sensor) may be incorrect.

#### 3. W/Wh/DEMAND Measurements

Rotate the Rotary switch to W/Wh/DEMAND. The instrument can perform Instantaneous, Integration and DEMAND measurements.  
START / STOP button to start / stop recording

	<b>6305</b>
Wiring connections	1P2W, 1P3W, 3P3W, 3P3W3A, 3P4W
Measurements	Voltage, Current, Frequency, Active power
Parameters	Apparent power, Reactive power, Active energy, Apparent energy, Reactive energy, Power factor (cos $\theta$ ), Neutral current
Voltage range[RMS]	150.0/300.0/600.0V
Voltage accuracy	$\pm 0.2\%rdg \pm 0.2\%f.s.$ (sine wave, 45 - 65Hz)
Current range[RMS]	10.00/50.00/100.0/250.0/500.0A/Auto (with clamp sensor MODEL8125)
Current accuracy	$\pm 0.2\%rdg \pm 0.2\%f.s.$ + Accuracy of Clamp sensor (sine wave, 45 - 65Hz) *+1% $f.s.$ at the lowest range.
Effective input range	10 - 110% of rating range
Display range	5 - 130% of each range (Voltage) 1 - 130% of each range (Current)
Crest factor	Voltage : up to 2.5, Current : up to 3.0 (with 90% fs or less)
Active power accuracy	$\pm 0.3\%rdg \pm 0.2\%f.s.$ + Accuracy of Clamp sensor *+1% $f.s.$ when the lowest current ranges is selected.
Effect of power factor	Active power: $\pm 1.0\%rdg \cos \theta = \pm 0.5$ (PF=1)
Frequency meter range	40.0 - 70.0Hz
Frequency meter accuracy	$\pm 3dgt$
Accuracy precondition	PF=1, Sine wave, 45 - 65Hz, 23°C $\pm 5^\circ C$
Display update period	1 second
Operating temperature and humidity range	0 - +50°C, less than 85% RH (without condensation)
Storage temperature and humidity range	-20 - +60°C, less than 85% RH (without condensation)
PC communication interface	USB, Bluetooth®
PC card interface	SD card (2GB)
Safety standard	IEC 61010-1 CAT III 600V
Power source (AC Line)	AC100 - 240V $\pm 10\%$ (50/60Hz)
Power source (DC battery)	LR6 or Ni-MH (HR-15-51) $\times 6$ (Battery charger not included), Battery life approx. 15h (LR6)
Power consumption	10VA (max.)
Dimension	175(L) $\times$ 120(W) $\times$ 65(D)mm
Weight	Approx. 800g (including batteries)
Accessories	7141B (Voltage test lead set: 4pcs), 7148 (USB cable), 7170(Powercord), 9125(Carrying case), 8326-02 (SD card 2GB), KEW Windows (PC Software), Battery(LR6) $\times 6$ , Quick manual
Optional	8124, 8125, 8126, 8127, 8128(Clamp sensor), 8130, 8133, 8135(Flexible clamp sensor), 8312(Power supply adaptor), 9132(Magnetic carrying case)

\*Some countries regulate the compliance with their Radio Law of the products equipped with Bluetooth®. Please confirm it with your distributor before purchasing our products equipped with Bluetooth®.



# POWER METERS

## Bluetooth® communication with Android application

Free Android software "KEW Smart 6305" is available on download site



Download



\*communication charges may be incurred separately to download application

### Real time & remote measurements using Android application

Measurement can be displayed in graphic or numeric forms on Android devices in real-time via Bluetooth® communication.

Remote checking of measurements is possible without accessing KEW6305.



Max communication distance: 10m

Android device

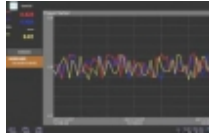

Real-time display

Bluetooth® is a registered trademark of the Bluetooth SIG, Inc. Android is a registered trademark of the Google Inc.

## Windows software

Automatic creation of graph and list from recorded data.

Uniform management of setting and recorded data acquired from multiple devices. Data can be expressed in crude oil and CO<sub>2</sub> equivalent values in the report.



### [System requirements]

OS: Windows® 11/10/8.1  
Display: XGA(Resolution 1024 × 768 dots) or more  
Hard-disk: space required 1Gbyte or more  
Other: With CD-ROM drive and USB port  
.NET Framework (3.5 or more)

\* Windows® is a registered trademark of Microsoft in the United States.

## Optional Accessories

### Load current clamp sensors

MODEL 8128



CE MAX 50A Ø24

MODEL 8127



CE MAX 100A Ø24

MODEL 8126



CE MAX 200A Ø40

MODEL 8125



CE MAX 500A Ø40

MODEL 8124



CE MAX 1000A Ø68

### Load current flexible clamp sensors

KEW 8135



CE MAX 50A Ø75

KEW 8130



CE MAX 1000A Ø110

KEW 8133



CE MAX 3000A Ø170

### Power supply adaptor

MODEL 8312

For taking single phase supply (100-240V) from the test leads to power the instrument (FUSE: 8923)



### Magnetic carrying case

MODEL 9132

For mounting inside metal distribution boards



## SD card Interface

SD cards up to 2GB can be used.

### Max amount of data (reference)

Data saved on:	SD card	Internal memory
Capacity	2GB	3MB
Instantaneous measurement	6,670,000	10,000
Integration / demand measurement interval	1 sec.	17 days
	1 min.	992 days
	30 min.	33 hours
Max number of file	511	4

\*in case the SD card is empty

## Selection Guide of Power Meters

		Clamp Power Meter			Power Meter	Power Quality Analyzer
		2060BT	2062	2062BT	6305	6315
Appearance						
Voltage [V]		✓	✓	✓	✓	✓
Current [A]		✓	✓	✓	✓	✓
Power [W]		✓	✓	✓	✓	✓
Frequency [Hz]		✓	✓	✓	✓	✓
Energy [Wh]		✓	✓	✓	✓	✓
Harmonics		✓	✓	✓	–	✓
Power Quality	Swell	–	–	–	–	✓
	Dip	–	–	–	–	✓
	Interruption	–	–	–	–	✓
	Transients	–	–	–	–	✓
	Inrush Current	–	–	–	–	✓
Conductor size		φ75mm	φ55mm	φ55mm	–	–
Memory		–	–	–	SD card	SD card
Number of Input Channel		4ch (V3, A1)	4ch (V3, A1)	4ch (V3, A1)	6ch (V3, A3)	7ch (V3, A4)
Communication interface		Bluetooth®	–	Bluetooth®	USB, Bluetooth®	USB, Bluetooth®

## Set Model



KEW 6305-01

KEW 6305 × 1  
MODEL 8125 × 3  
Carrying case : 9125



KEW 6305-03

KEW 6305 × 1  
MODEL 8130 × 3  
Carrying case : 9135

KEW 6305-05

KEW 6305 × 1  
MODEL 8133 × 3  
Carrying case : 9135

# POWER QUALITY ANALYZER

KEW **6315**



TYPE RMS USB Bluetooth External Power Supply



- Simultaneous Power & Power quality measurements  
Power/Harmonics/Waveform/Power quality are recorded at all CHs. (Voltage:3ch,Current 4ch)
- Helpful support functions  
Quick Start Guide,Wiring check and Sensor detection for easy and reliable measurement
- Measurement with high accuracy  
Guaranteed accuracy:  $\pm 0.3\% \text{rdg}(\text{energy})$ ,  
 $\pm 0.2\% \text{rdg}(\text{voltage/current})$   
Complies with the International Standard  
IEC 61000-4-30 Class S and the European Standard EN50160
- Energy consumption check on site  
Trend and demand graphs for easy recognition. TFT color display with high resolution.
- IEC 61010-1 CAT IV 300V,CAT III 600V,CAT II 1000V

		6315
Wiring connections		1P2W, 1P3W, 3P3W, 3P4W
Measurements and parameters		Voltage, Current, Frequency, Active power, Reactive power, Apparent power, Active energy, Reactive energy, Apparent energy, Power factor (cosφ), Neutral current, Transients/ Over Demand, Harmonics, Quality(Swell/Dip/Interruption, voltage, Inrush current, Unbalance rate), Phase advance condenser, IEC Flicker
Other functions		Digital output function, External communication function,Scaling function
Voltage [RMS]	Range	600.0/1000V
	Accuracy	600.0V Range : (sine wave 40 - 70Hz) 10% - 150% against 100V or more of nominal V : Nominal V $\pm 0.5\%$ Out of above range : $\pm 0.2\% \text{rdg} \pm 0.2\% \text{f.s.}$ 1000V Range : $\pm 0.2\% \text{rdg} \pm 0.2\% \text{f.s.}$ (sine wave 40 - 70Hz)
	Allowable input	1 - 120% of each range (rms). 200% of each range (peak)
	Display range	0.15 - 130% of each range
	Crest factor	3 or less
	Sampling speed	24μs
Current [RMS]	Range	8128/8135(50A type): 5000mA/50.00A/AUTO 8127(100A type): 10.00/100.0A/AUTO 8126(200A type): 20.00/200.0A/AUTO 8125(500A type): 50.00/500.0A/AUTO 8124/8130(1000A type): 100.0/1000A/AUTO 8146/8147/8148(10A type): 1000mA/10.00A/AUTO 8133(3000A type): 300.0/3000A/AUTO
	Accuracy	$\pm 0.2\% \text{rdg} \pm 0.2\% \text{f.s.}$ + accuracy of clamp sensor (sine wave, 40 - 70Hz)
	Allowable input	1 - 110% of each range (rms). 200% of each range (peak)
	Display range	0.15 - 130% of each range
	Crest factor	3 or less
	Influence of power factor	$\pm 1.0\% \text{rdg}$ (reading at power factor 0.5 against power factor 1)
Active power	Accuracy	$\pm 0.3\% \text{rdg} \pm 0.2\% \text{f.s.}$ + accuracy of clamp sensor (power factor 1, sine wave, 40 - 70Hz)
Frequency meter range		40 - 70Hz
Power source (AC Line)		AC100 - 240V/50 - 60Hz/7VA max
Power source (DC battery)		LR6 or Ni-MH(HR15-51) × 6 Battery life approx. 3h (LR6,Backlight OFF)
Memory card		SD card (2GB)
PC communication interface		USB Ver2.0, Bluetooth® Ver2.1+EDR Class2*
Display		320 × 240(RGB)Pixel, 3.5inch color TFT display
Temperature and humidity range		23 $\pm 5^\circ\text{C}$ less than 85% RH (without condensation)
Operating temperature and humidity range		0 - 45 $^\circ\text{C}$ less than 85% RH (without condensation)
Storage temperature and humidity range		-20 - 60 $^\circ\text{C}$ less than 85% RH (without condensation)
Applicable Standards		IEC 61010-1 CAT IV 300V, CAT III 600V, CAT II 1000V Pollution degree 2, IEC 61010-2-030, IEC 61010-031, IEC 61326, EN 50160 IEC 61000-4-30 Class S, IEC 61000-4-15, IEC 61000-4-7
Dimension/Weight		175(L) × 120(W) × 68(D) mm/approx 900g
Accessories		7141B(Voltage test lead), 7170(Power cord), 7219(USB cable), 8326-02(SD card 2GB), 9125(Carrying case),Input terminal plate × 6, KEW Windows for KEW6315(software), Quick manual, LR6(AA) × 6

\*Some countries regulate the compliance with their Radio Law of the products equipped with Bluetooth®. Please confirm it with your distributor before purchasing our products equipped with Bluetooth®.

## Simultaneous Power & Power quality measurements



### Power & Energy



#### Instantaneous value

- Measures instantaneous / average / min / max for voltage, current, active / reactive / apparent power, PF (cosφ) and line frequency all on one screen.
- Trend of all main parameters and customized Zoom functions.

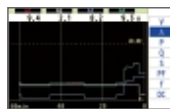

#### Integration value

- The display will list the active / reactive / apparent energy in total and for each phase consumed (or generated in case of co-generation like solar panels, etc).

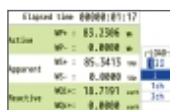

#### Demand

- To support demand control, present energy usage and estimated value are displayed on a graph while recording max demand value and the occurred time.

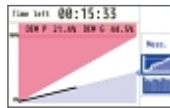

### Vector

- Can display voltage and current by vector per Ch.

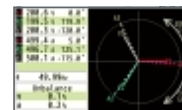

### Waveform

- Displays voltage and current on each Ch by waveform.

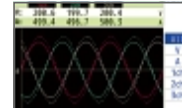

### Harmonics Analysis

- Graphic display of harmonic components up to 50th order for voltage, current and power.

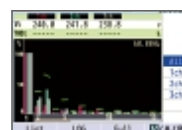

### Event

- Measures voltage swells / dips / interruptions / transients and inrush currents that may indicate a weak power distribution system. Such phenomena may damage or reset devices. All necessary data is displayed by pressing one key.

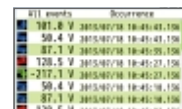



# POWER QUALITY ANALYZER

## Quick Start Guide

One-Touch START/STOP Key for Quick Start Guide providing easy setup guides.

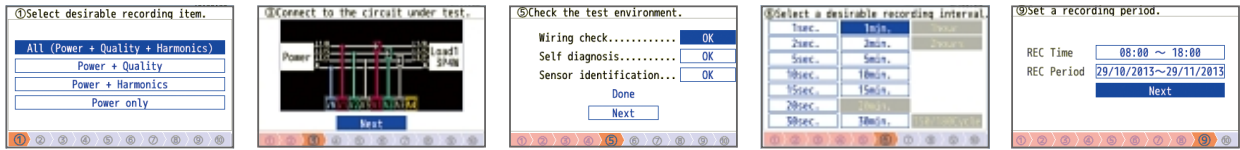

Guide start

Connect to the circuit

Wiring check

Select interval

Set recording time

Start recording

## Windows software for data analysis and setting via USB port

- Automatic creation of graph and list from recorded data.
- Uniform management of setting and recorded data acquired from multiple devices.
- Data can be expressed in crude oil and CO<sub>2</sub> equivalent values in the report.
- EN 50160 report can be generated after survey.

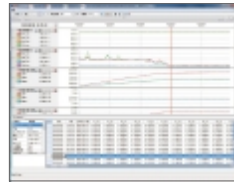

<System requirements>

- OS: Windows® 11/10/8.1
- Display: XGA(Resolution 1024 × 768 dots) or more
- Hard-disk: Space required 1Gbyte or more
- Other: With CD-ROM drive and USB port, NET Framework (3.5 or more)

※Windows® is registered trademark of Microsoft in the United States.

## Real time and Remote measurements

- Measurements can be graphically displayed on Android devices or PC in real-time via Bluetooth® communication.

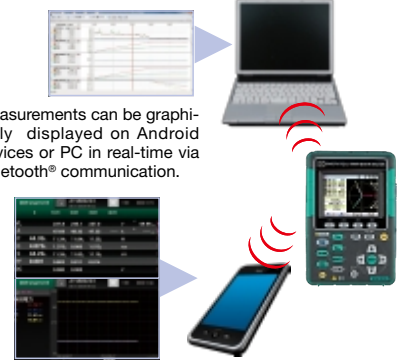

※Bluetooth® is a registered trademark of the Bluetooth SIG, Inc.  
Android™ is a registered trademark of the Google Inc.

## Optional Accessories

### Load current clamp sensors



### Leakage & Load current clamp



※8146/8147/8148 can measure up to 10A for use in KEW 6315

### Load current flexible clamp sensors



### Can you close your distribution board door during surveys?

The KEW6315 facilitates safe testing by being extremely compact and with two clever option extras: a magnetic case(9132) for attaching it to the sides of metal enclosures and a power supply adaptor(8312) which takes the power for the instrument from the supply being measured.



## SD card Interface

SD cards up to 2GB can be used

Possible recording time  
When the 2GB of SD is used:



Interval	REC item	
	Power	+Harmonics
1sec	13days	3days
1min	1-year or more	3months
30min	10-year or more	7-year or more

Data of power quality events are not considered to estimate the possible recording time. The max possible time will be shortened by recording such events.

## Set Model



**KEW 6315-01**  
8125(500A) × 3  
Carrying case : 9125



photo : 6315-03

**KEW 6315-03** **KEW 6315-04** **KEW 6315-05**  
8130(1000A) × 3    8130(1000A) × 4    8133(3000A) × 3  
Carrying case : 9135    Carrying case : 9135    Carrying case : 9135

# LOGGERS

## KEW 5010 (for Current) KEW 5020 (for Current/Voltage)



**3 channel inputs for the simultaneous recording of Leakage Current, Load Current and Voltage**

**Power Quality analysis. (only on KEW 5020)**

(Power Quality: Reference voltage, Swell, Dip, Short power Interruptions)

**Large capacity for storing 60,000 data points**

60,000 data points can be recorded when 1ch is used, and when all the three channels are used, 20,000 data points per channel can be recorded.

**Lowpass Filter will filter out the harmonics.**

(Cutoff Frequency = Approx. 160Hz)

**LED flickers when the preset current / voltage value is exceeded.**

(Available for Trigger / Capture Recording, Power Quality Analysis modes)

**CALL : Confirmation of recorded data**

- The following can be displayed: number of recorded data points, (max+ min+ peak) value for each channel complete with time/date information in the Normal recording mode. (Detected values (i.e. when values are outside preset limits) can be displayed in other recording modes)
- RECALL: The last 10 recorded data points including time/date can be recalled on the logger display.



### Selection of One-time mode or Endless mode

**One-time on : →**

Recording will stop when memory is used up.

**One-time off : ↻**

Overwrite the old data, and store the latest data.

### Non Volatile Memory

Recorded data will be retained even if the batteries are exhausted or replaced due to the presence of a nonvolatile memory (guaranteed for 10 years)

### Battery power indicator

Indicates battery voltage in 4-levels.

(It is possible to use the logger for a further approx 24 hours even after the warning symbol is flashing.)

### The user friendly PC software " KEW LOG Soft "is supplied.

- Supplied with the user friendly software " KEW LOG Soft 2".
- This permits editing, analysis and graphical display of data.
- The recorded data is downloadable onto a PC via USB cable.
- Variation of the measured voltage and current data can be confirmed simultaneously on the PC display monitor. (only on KEW 5020)
- Simplified Power Integration  
(The "KEW LOG Soft 2" uses current and voltage recorded to calculate the integral power consumption)
- Continuous measuring time : Approx. 10 days (Alkaline Battery)

	5010	5020
Recording mode	Normal, Trigger, Capture	Normal, Trigger, Capture, Power quality analysis
Operating system	Successive approximation(CH1 single synchronized sampling)	
Rated max. working voltage	AC9.9Vrms, 14V peak value	
Number of input channel	3ch	
Measuring method	True RMS	
RMS measuring interval	approx. 100ms.	
Sampling interval	: Normal / Trigger mode	approx. 1.65ms/CH
	: Capture mode	approx. 0.55ms (waveform: at every 1.1ms)
	: P.Q.A mode	—
		approx. 0.55ms
Low battery warning	Battery mark display (in 4 levels)	
Over-range indication	"OL" mark is displayed when exceeding the measuring range	
Auto power off	Power-off function operates automatically after a switch remains for 3min. (when recording is stopped)	
Location for use	Indoor use, Altitude up to 2000m	
Operating temperature & humidity range	-10 - 50°C / Relative humidity 85% or less (no condensation)	
Battery	LR6(AA)(1.5V) × 4 / External supply DC9V(Special AC Adaptor)	
Possible measurement time	Approx.10days (with alkaline LR6 batteries)	
Applicable Standards	IEC 61010-1 CAT III 300V Pollution degree2 IEC 61326 (EMC)	
Dimensions	111(L) × 60(W) × 42(D)mm	
Weight	Approx. 265g	
Accessories	LR6(AA) × 4 9118(Carrying case[Soft]) KEW LOG Soft 2(PC software) 7148(USB cable) Instruction manual Quick manual Install manual USB Notice sheet	
Optional	8146,8147,8148(Leakage & Load current clamp sensor) 8121,8122,8123,8124,8125,8126,8127,8128(Load current clamp sensor) 8130,8135(Flexible clamp sensor) 8309(Voltage sensor : only KEW5020) 8320(AC adaptor) 9135(Carrying case) 7185(Extension cable)	

### Normal Recording Mode

(AC 50/60Hz, Sine wave, Input: 10% or more of the range at CH1)

Range	RMS Accuracy
100.0mA	±2.0%rdg±0.9%f.s. + Accuracy of sensor
Other ranges	±1.5%rdg±0.7%f.s. + Accuracy of sensor
Crest factor	2.5 or less :RMS accuracy(sine)+ 2%rdg+1%f.s.

\*Max, Min and Instant Peak values in Normal Recording mode are just reference values; their accuracies aren't guaranteed.

### Trigger Recording Mode

(AC 50/60Hz sine wave)

Range	Accuracy
100.0mA	±3.5%rdg±2.2%f.s. + Accuracy of sensor
Other ranges	±3.0%rdg±2.0%f.s. + Accuracy of sensor

### Capture/ Power Quality Analysis Recording Mode

Range	Accuracy
100.0mA	±3.0%rdg±1.7%f.s. + Accuracy of sensor
Other ranges	±2.5%rdg±1.5%f.s. + Accuracy of sensor



## 4 recording modes make various measurements possible



### Normal recording mode

**NORM** For monitoring power line status or an intermittent leakage.

- Records the variation of the current / voltage in a given interval (For monitoring the variation of the current / voltage against time.)
- A choice of 15 recording intervals are available: 1 sec. to 60 min. (1,2,5,10,15,20,30 sec, 1,2,5,10,15,20,30,60 min.)
- The average of the measured value in every recording interval is recorded. The Max., Min. and Peak values (sampled crest value converted to sine RMS value) are recorded every 10 readings.

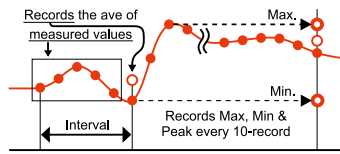

### Trigger recording mode

**TRIG** For observing an irregular operation of an ELCB/RCD, an irregular current / voltage.

- Detects the value, time and frequency of the current / voltage when the preset value is exceeded.
- When the detection level (i.e. preset value) is exceeded, 8 data points (True RMS values for approx. 0.8 sec) and peak value are recorded before and after the preset value is exceeded.
- Inrush current or an abnormal current / voltage can be detected by sampling the inputs at every 1.6ms.
- LED flickers when the measured values exceed the preset current / voltage value.

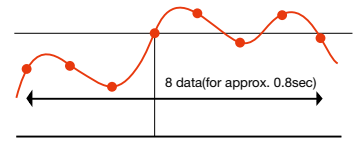

### Capture recording mode

**CAP** For observing waveforms easily.

- Waveform display via a PC by sampling the inputs every 0.55ms.
- When the preset current / voltage value is exceeded, instantaneous values are recorded for 200ms (from 10(50Hz) to 12 (60Hz) waveforms) before and after preset value is exceeded.
- LED flickers when the measured values exceed the preset current / voltage value.

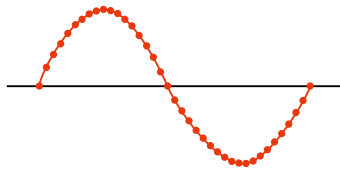

### Power Quality Analysis Mode

**PQA** For monitoring and observing voltage fluctuations.

- Detects the reference voltage, Swell, Dip and Short Interruption. Records the values detected with the start time and end time.
- Samples the inputs every 0.55ms and detects the voltage fluctuation every 10ms.
- LED flickers when the voltage fluctuation is detected.

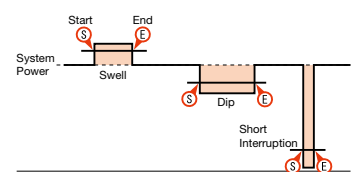

## Analyzing and processing the recorded data with a PC

The user friendly PC software “KEW LOG Soft 2” is supplied.

**Software is Enhanced!**



- The type of the sensor connected to the logger will be automatically recognized.
- Just click appropriate dialog boxes for set up if it is not required to input any comments.
- By using commercially available USB hub, multiple loggers can be connected to a PC and can set the synchronized time.

#### System requirements

OS: Windows® 11/10/8.1/8  
 Display: XGA(Resolution 1024 × 768 dots) or more  
 Hard-disk: Space required 100Mbyte or more  
 Others: With CD-ROM drive and USB port  
 \* Windows® is a registered trademark of Microsoft in the United States.

A graph can be made by just one click



Display of Power Quality

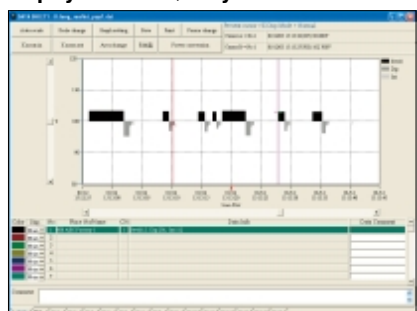

### Selection Guide of Loggers

	Loggers		
	5010	5020	5050
Appearance			
Voltage [V]	-	✓	✓
Current [A]	✓	✓	✓
lor Resistive leakage current [mA]	-	-	✓
Frequency [Hz]	-	-	✓
Power Quality	Swell	-	✓
	Dip	-	✓
	Interruption	-	✓
	Inrush Current	✓	✓
Memory	Inner memory	Inner memory	SD card
Number of Input Channel	3ch	3ch	5ch (V1, A4)

## KEW 5050



Kew 5050 is an innovative Leakage Current Logger that can identify the resistive component of leakage current (Ior) in an electrical installation. Despite the capacitive component, the Ior is the dangerous component of the leakage current because Ior consumes power and then it can cause a rise in temperature that can lead to a fire and electric shock.

- Provides simultaneous measurements and logs up to 4 channels
- Supports various wiring systems (Single-phase 2&3-wire, Three-phase 3&4-wire\*) \*Except Ior for 3 Phase 4 wire
- World's fastest 200ms interval for leakage current measurement
- Offers both traditional leakage / load current measurements
- Large graphic display and magnet on the back case to attach it on metal enclosures

### Can measure up to 4 channels simultaneously!

#### Best to diagnose unwanted RCD tripping

The RCD often trips. Caused by capacitive leakage current? Or caused by the dangerous resistive leakage current of a degraded insulation?

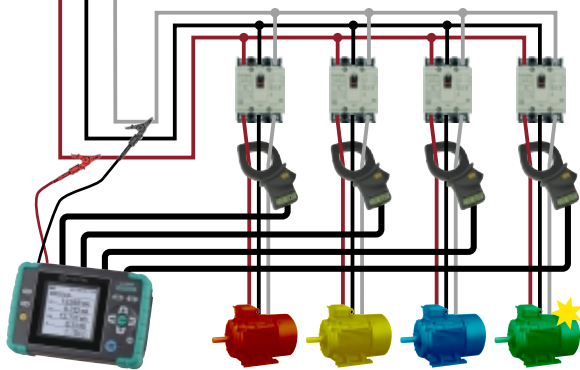

### Gapless continuous measurement

Performs fast sampling (24.4 μsec) continuously with gapless during logging to prevent intermittent leakages being overlooked as an event or max value.

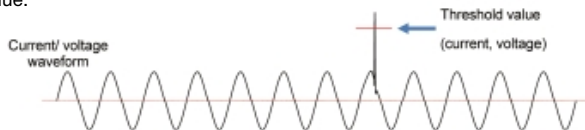

	5050
Wiring configuration	1P2W, 1P3W, 3P3W, 3P4W
Measurements and parameters	Ior : Leakage current (Trms) with resistive components only Io : Leakage current (Trms) with basic wave of 40 - 70Hz Iom : Leakage current (Trms) including harmonic components V : Reference voltage (Trms) with basic wave of 40 - 70Hz Vm : Reference voltage (Trms) including harmonic components R : Insulation resistance, Frequency(Hz), Phase angle(θ)
Other functions	Digital output, Print screen, Back light, Data hold
Recording Interval	200/400ms/1/5/15/30s/1/5/15/30m/1/2hours
Ior	
Range	10.000/100.00/1000.0mA/10.000A/AUTO
Accuracy	For reference voltages of sine wave 40 - 70Hz and 90V Trms or higher, ±0.2%rdg±0.2%f.s. + clamp sensor amplitude accuracy + error of phase accuracy* (phase error) * add ±2.0%rdg to measured Io value when using Ior leakage clamp sensor. (θ : within the accuracy of reference voltage/ current phase difference ±1.0°)
Allowable input	1% - 110% (Trms) of each range, and 200% (peak) of the range
Display range	0.15% - 130% (display "0" for less than 0.15%, "OL" if the range is exceeded)
Io *Range, Allowable input and Display Range are the same as Ior .	
Accuracy	±0.2%rdg±0.2%f.s.+ clamp sensor amplitude accuracy
Iom *Range, Allowable input and Display Range are the same as Ior .	
Accuracy	±0.2%rdg±0.2%f.s.+ clamp sensor amplitude accuracy
Measurement method	Sampling speed 40.96ksp/s (every 24.4μs), gapless, calculate Trms values every 200ms.
Voltage	
Range	1000.0V
Accuracy	±0.2%rdg±0.2%f.s. * for waveforms of sine wave 40 - 70Hz
Allowable input	10 - 1000V Trms, and 2000V peak
Display range	0.9V - 1100.0V Trms (display "0" for less than 0.9V, "OL" if the range is exceeded)
Phase angle(θ)	
Display range	0.0° - ±180.0° (regarding the phase of reference voltage as 0.0°)
Accuracy	Within ±0.5° for the inputs of 10% or higher of leakage current range, sine wave 40 - 70Hz, reference voltage of 90V Trms or higher. Within ±1.0° when using Ior leakage clamp sensor, and Within ±0.5°+ clamp sensor accuracy when using general purpose clamp sensor.
Frequency meter range	40 - 70Hz
External supply	AC100 - 240V(50/60Hz) 7VA max
Power source	LR6(AA)(1.5V) × 6 (Battery life approx. 11h)
Display / update period	160 × 160dots, FSTN monochrome display / 500ms
PC card interface	SD card (2GB) *standard accessory
PC communication-interface	USB Ver2.0
Temperature and humidity range	23±5°C, less than 85%RH(without condensation)
Operating temperature and humidity range	-10 - 50°C less than 85%RH(without condensation)
Storage temperature and humidity range	-20 - 60°C less than 85%RH(without condensation)
Applicable Standards	IEC 61010-1 CAT IV, 300V CAT III 600V Pollution degree 2 IEC 61010-2-030, IEC 61010-031, IEC 61326
Dimension/Weight	165(L) × 115(W) × 57(D)mm/approx. 680g (including batteries)
Accessories	7273(Voltage test lead) 8262(AC adapter) 7278(Earth cable) 7219(USB cable) 8326-02(SD card 2GB) 9125(Carrying case) Instruction manual, Cable marker, Software installation manual LR6(AA) × 6 KEW Windows for KEW 5050(Software)
Optional	8177(Ior Leakage clamp sensor 10A type φ40mm) 8178(Ior Leakage clamp sensor 10A type φ68mm) 8329(Power supply adapter)
Optional sensors (It cannot be used for Ior measurement)	8146, 8147, 8148 (Leakage & Load clamp sensor) 8130, 8133 (Flexible sensor) 8121, 8122, 8123 (Load clamp sensor) 8124, 8125, 8126, 8127, 8128 (Load clamp sensor)

Shows insulation resistance (R) values determined by the following formula.

V: Reference voltage/ Ior: Leakage current

Displayed value is just for reference since the measurement method differs from insulation resistance testers and may not be consistent with each other.

In case of 3P3W and 3P4W, for a correct Ior reading, the capacitance effect of each phase must be equal.



# Ior LOGGER

## Quickly displays occurred events

Detailed information on the occurred events are displayed on the LCD. Different threshold values can be set for each channel and each event.

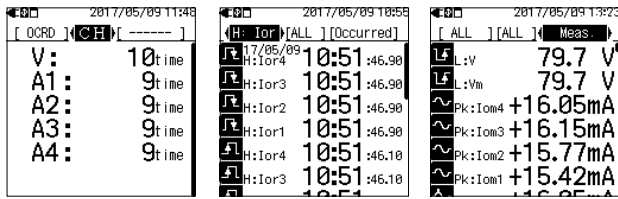

## Various display modes

User-friendly graphical display of connections and phase differences

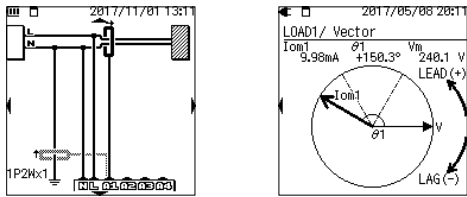

## New Measurement method with FFT

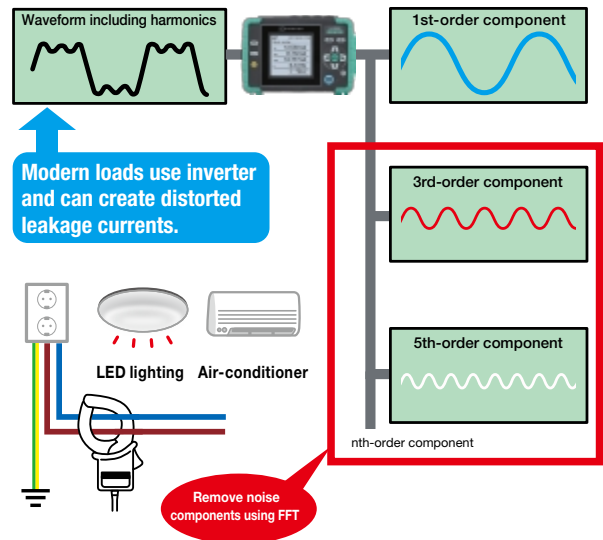

Unlike to traditional measuring apparatus, less susceptible to harmonics noises. Successfully achieving logging with no effects of harmonics by True RMS calculation every 200 ms using FFT (Fast Fourier Transform).

## Windows software

One-click graph and list generation. Visualizes timeline based graphs for easy analysis. Data can be checked without using this software by changing the file extension to csv or others.

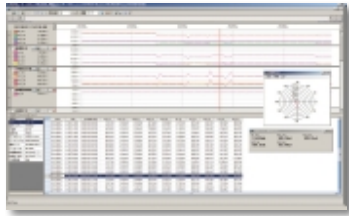

**[System requirements]**  
 OS: Windows® 11/10/8.1/8  
 Display: XGA (1024 × 768) or higher  
 HDD: 1Gbyte or more  
 Other: CD-ROM drive, USB port, .NET Framework 3.5, 4.6  
\* Windows® is a registered trademark of Microsoft in the United States.

## SD card interface

Achieves long period of data logging. In case of sudden power interruption, data stored in the SD card aren't lost.

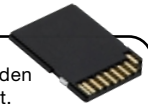

Interval	Possible recording time (with 2GB SD card)		
	REC item		
	1P3W × 1	1P3W × 4	3P4W × 4
200 ms	25 days	8 days	7 days
1 sec	38 days	11 days	9 days
2 sec	76 days	22 days	18 days
5 sec	6.5 months	1.8 months	1.5 months
15 sec	1-year or more	5 months	4 months
30 sec		11 months	9 months
1 min or more		1-year or more	

## Accessories

<b>MODEL 7273</b> Voltage test lead 3000mm	<b>MODEL 8262</b> AC adapter	<b>MODEL 7278</b> Earth cable 1500mm	<b>MODEL 7219</b> USB cable 1950mm	<b>MODEL 8326-02</b> SD card	<b>MODEL 9125</b> Carrying case	KEW Windows for KEW 5050 Software	Cable marker

## Optional Accessories

<b>Ior Leakage clamp sensor</b> <b>KEW 8178</b>  MAX 10A Ø68	<b>KEW 8177</b>  MAX 10A Ø40	<b>Power supply adaptor</b> <b>MODEL 8329</b>  Power source can be taken through the measured line (100 - 240V) (FUSE : 8923)
---	------------------------------------	--

## Set Model

	<b>KEW 5050-01</b> + KEW 8178 (φ68) × 1
	<b>KEW 5050-02</b> + KEW 8177 (φ40) × 1
Carrying case: 9125	

# SENSORS

## Optional Accessories of Loggers, Power Meter and Power Quality Analyzer

### Applicable model table

Sensor	Load current		5010	5020	5050	6305	6315		
Sensor	Load current	8121	✓	✓	✓*6				
		8122	✓	✓	✓*6				
		8123	✓	✓	✓*6				
		8124	✓	✓	✓*6	✓	✓		
		8125	✓*1	✓*1	✓*6	✓	✓		
		8126	✓*2	✓*2	✓*6	✓	✓		
		8127	✓*3	✓*3	✓*6	✓	✓		
		8128	✓	✓	✓*6	✓	✓		
		8130	✓*4	✓*5	✓*6	✓	✓		
		8133			✓*6	✓	✓		
		8135	✓	✓		✓	✓		
		Leakage & Load current		8146	✓	✓	✓*6		✓*7
				8147	✓	✓	✓*6		✓*7
8148	✓			✓	✓*6		✓*7		
Ior Leakage current		8177			✓				
		8178			✓				
Voltage sensor		8309		✓					
Adaptor		8312				✓	✓		
		8320	✓	✓					
		8329			✓				
Case		9132				✓	✓		
		9135	✓	✓					

\*1 - 5: Can use with after the following serial numbers.

\*1: 8125 No.02637 -  
\*2: 8126 No.00151 -  
\*3: 8127 No.00181 -  
\*4: 5010 No.8029792 -  
\*5: 5020 No.8031560 -

\*6: Cannot be used for Ior measurement.  
\*7: Cannot be used for power measurement.

#### MODEL 8312

Power supply adaptor



Power source can be taken through the measured line (100 - 240v)(FUSE : 8923)

#### MODEL 9132

Carrying case with magnet



Easy-to-use setting with magnet on the steel plate etc. of switch board

#### MODEL 8320

AC adaptor (External power supply)



Appropriate for a longer period of recording. Complies to 90 - 264V(45 - 66Hz).

#### MODEL 9135

Carrying case



Dimensions : 250(L) × 270(W) × 216(D)mm

#### MODEL 8329

Power supply adaptor



Power source can be taken through the measured line (100 - 240v)(FUSE : 8923)

## Ior Leakage current Clamp sensors

KEW **8177**

KEW **8178**

MAX 10A Ø40

MAX 10A Ø68



	8177	8178
Conductor size	φ40mm	φ68mm
Rated current	10A (rms) AC (14.1Apeak)	
Output voltage	500mV AC/10A AC	
Accuracy	±1.0%rdg±0.025mV (40Hz - 70Hz) ±4.0%rdg±0.025mV (30Hz - 5kHz, with inputs of 100mA or more)	
Phase shift	within 1.0° (45 - 70Hz while combining with KEW 5050, under the input of 10% or more of KEW 5050 leakage current range)	
Cable length : Output connector	Approx. 3m : MINI DIN 6pin	
Operating temperature & humidity ranges	-10 - 50°C, relative humidity 85% or Less (no condensation)	
Output impedance	Approx. 100Ω or less	Approx. 60Ω or less
Applicable Standards	IEC 61010-1, IEC 61010-2-032 CAT III 300V Pollution degree 2, IEC 61326-1	
Dimensions	128(L) × 81(W) × 36(D)mm	186(L) × 129(W) × 53(D)mm
Weight	Approx. 280g	Approx. 560g
Accessories	9095 (Carrying case), Instruction manual, Cable marker	9094 (Carrying case), Instruction manual, Cable marker
Applicable model	5050	

## Voltage sensor

KEW **8309**



	8309
Max. input voltage	AC 600Vrms(sin), 848.4Vpeak
Input system	Differential input (can measure floating voltage)
Output voltage	AC 0 - 60mV (output/input : 0.1mV/V)
Measuring ranges	6 - 600V
Accuracy	±1.0%rdg±0.1mV (50/60Hz)
Operating temperature & humidity ranges	-10 - 50°C, less than 85% RH (no condensation)
Input impedance	Approx. 3.4MΩ
Output impedance	Approx. 180Ω
Cable length: Output connector	Approx. 2m : MINI DIN 6PIN
Applicable Standards	IEC 61010-1 CAT. III 600V Pollution degree 2, IEC 61010-031, IEC 61326 (EMC)
Dimensions/Weight	87(L) × 26(W) × 17(D)mm (excluding protrusions)/Approx. 135g
Accessories	Instruction manual
Optional	7185 (Extension cable)
Applicable model	5020



# SENSORS

## Load current Clamp sensors

KEW **8135** **NEW**

KEW **8130**

KEW **8133**

MAX 50A Ø75



MAX 1000A Ø110



MAX 3000A Ø170



	8135	8130	8133
Conductor size	max. $\phi$ 75mm	max. $\phi$ 110mm	max. $\phi$ 170mm
Rated current	AC 5A(Max.50A)	AC 1000A	AC 3000A
Output voltage	AC 500mV/ AC 50A (10mV/A)	AC 500mV/1000A (AC 0.5m V/A)	AC 500mV/3000A (AC 0.167m V/A)
Accuracy	$\pm 1.0\%$ rdg $\pm 0.5$ mV (45 - 65Hz) (0 - 50A) $\pm 1.5\%$ rdg $\pm 0.5$ mV (40 - 300Hz) (0 - 20A) $\pm 1.5\%$ rdg $\pm 0.5$ mV (300Hz - 1kHz) (0 - 5A)	$\pm 0.8\%$ rdg $\pm 0.2$ mV (45 - 65Hz) $\pm 1.5\%$ rdg $\pm 0.4$ mV (40Hz - 1kHz)	$\pm 1.0\%$ rdg $\pm 0.5$ mV (45 - 65Hz) $\pm 1.5\%$ rdg $\pm 0.5$ mV (40Hz - 1kHz)
Phase shift	within $\pm 3.0^\circ$ (45 - 65Hz), within $\pm 4.0^\circ$ (40Hz - 1kHz)	within $\pm 2.0^\circ$ (45 - 65Hz), within $\pm 3.0^\circ$ (40Hz - 1kHz)	
Cable length Output connector	Approx. 3m MINI DIN 6pin		
Operating temperature & humidity ranges	-10 - 50°C, relative humidity 85% or less (no condensation)		
Output impedance	100 $\Omega$ or less		
Applicable Standards	IEC 61010-1, IEC 61010-2-032 CAT IV 300V CAT III 600V Pollution degree 2, IEC 61326	IEC 61010-1, IEC 61010-2-030, IEC 61010-2-032 CAT IV 300V /CAT III 600V Pollution degree 2, IEC 61326	
Dimensions	AMP box 65(L) $\times$ 24(W) $\times$ 22(D)mm(except for protrusions)		
Weight	Approx. 170 g	Approx. 180g	Approx. 200g
Accessories	Instruction manual Cable marker 9095(Carrying case)		
Applicable models	5010, 5020, 6305, 6315	5010, 5020, 5050(Cannot be used for lor measurement.), 6305, 6315	5050(Cannot be used for lor measurement.), 6305, 6315

MODEL **8128**

MODEL **8127**

MODEL **8126**

MODEL **8125**

MODEL **8124**

MAX 50A Ø24



MAX 100A Ø24



MAX 200A Ø40



MAX 500A Ø40



MAX 1000A Ø68



	8128	8127	8126	8125	8124
Conductor size	$\phi$ 24mm	$\phi$ 24mm	$\phi$ 40mm	$\phi$ 40mm	$\phi$ 68mm
Rated current	AC 5A (Max.50A)	AC 100A	AC 200A	AC 500A	AC 1000A
Output voltage	AC 50mV/5A [Max. 500mV/50A](AC 10mV/A)	AC 500mV/100A (AC 5mV/A)	AC 500mV/200A (AC 2.5mV/A)	AC 500mV/500A (AC 1mV/A)	AC 500mV/1000A (AC 0.5mV/A)
Accuracy	$\pm 0.5\%$ rdg $\pm 0.1$ mV (50/60Hz) $\pm 1.0\%$ rdg $\pm 0.2$ mV (40Hz - 1kHz)				$\pm 0.5\%$ rdg $\pm 0.2$ mV (50/60Hz) $\pm 1.5\%$ rdg $\pm 0.4$ mV (40Hz - 1kHz)
Phase shift	within $\pm 2.0^\circ$ (45 - 65Hz)		within $\pm 1.0^\circ$ (45 - 65Hz)		
Cable length : Output connector	Approx. 3m : MINI DIN 6pin				
Operating temperature ranges	-0 - 50°C, less than 85% RH ( without condensation)				
Output impedance	Approx. 20 $\Omega$	Approx. 10 $\Omega$	Approx. 5 $\Omega$	Approx. 2 $\Omega$	Approx. 1 $\Omega$
Applicable Standards	IEC 61010-1, IEC 61010-2-032 CAT III 300V Pollution degree 2 IEC 61326		IEC 61010-1, IEC 61010-2-032 CAT III 600V Pollution degree 2 IEC 61326		
Dimensions	100(L) $\times$ 60(W) $\times$ 26(D)mm		128(L) $\times$ 81(W) $\times$ 36(D)mm		186(L) $\times$ 129(W) $\times$ 53(D)mm
Weight	Approx. 160g		Approx. 260g		Approx. 510g
Accessories	9095 (Carrying case), Instruction manual, Cable marker				9094 (Carrying case) Instruction manual, cable marker
Optional	7146 (Banana $\phi$ 4 adjuster plug), 7185 (Extension cable)				
Applicable models	5010, 5020, 5050(Cannot be used for lor measurement.), 6305, 6315				

# SENSORS

## Leakage & Load current Clamp sensors

KEW **8146**

MAX  
30A Ø24  
CE



KEW **8147**

MAX  
70A Ø40  
CE



KEW **8148**

MAX  
100A Ø68  
CE



	8146	8147	8148
Conductor size	φ24mm	φ40mm	φ68mm
Rated current	AC 30A	AC 70A	AC 100A
Output voltage	AC 1500mV/30A (AC 50mV/A)	AC 3500mV/70A (AC 50mV/A)	AC 5000mV/100A (AC 50mV/A)
Accuracy	0 - 15A ±1.0%rdg±0.1mV (50/60Hz)±2.0%rdg±0.2mV (40Hz - 1kHz) 15 - 30A ±5.0%rdg (50/60Hz),±10.0%rdg (45Hz - 1kHz)	0 - 40A ±1.0%rdg±0.1mV (50/60Hz),±2.0%rdg±0.2mV (40Hz - 1kHz) 40 - 70A ±5.0%rdg (50/60Hz),±10.0%rdg (45Hz - 1kHz)	0 - 80A ±1.0%rdg±0.1mV (50/60Hz),±2.0%rdg±0.2mV (40Hz - 1kHz) 80 - 100A ±5.0%rdg (50/60Hz),±10.0%rdg (45Hz - 1kHz)
Cable length : Output connector	Approx. 2m : MINI DIN 6pin		
Operating temperature ranges	-0 - 50°C, less than 85% RH (without condensation)		
Output impedance	Approx. 90Ω	Approx. 100Ω	Approx. 60Ω
Applicable Standards	IEC 61010-1, IEC 61010-2-032 CAT III 300V Pollution degree 2, IEC 61326		
Dimensions	100(L) × 60(W) × 26(D)mm	128(L) × 81(W) × 36(D)mm	186(L) × 129(W) × 53(D)mm
Weight	Approx. 150g	Approx. 240g	Approx. 510g
Accessories	9095(Carrying case), Instruction manual, Cable marker		9094 (Carrying case), Instruction manual, Cable marker
Optional	7146(Banana φ4 adjuster plug), 7185(Extension cable)		
Applicable models	5010, 5020, 5050(Cannot be used for Ior measurement.), 6315(Cannot be used for power measurements.)		

## Load current Clamp sensors

KEW **8121**

MAX  
100A Ø24  
CE



KEW **8122**

MAX  
500A Ø40  
CE



KEW **8123**

MAX  
1000A Ø55  
CE



	8121	8122	8123
Conductor size	φ24mm	φ40mm	φ55mm
Rated current	AC 100A	AC 500A	AC 1000A
Output voltage	AC 500mV/100A (AC 5mV/A)	AC 500mV/500A (AC 1mV/A)	AC 500mV/1000A (AC 0.5mV/A)
Accuracy	±2.0%rdg±0.3mV (50/60Hz), ±3.0%rdg±0.5mV (40Hz - 1kHz)		
Cable length : Output connector	Approx. 2m : MINI DIN 6pin		
Operating temperature ranges	-0 - 40°C, less than 85% RH (without condensation)		
Output impedance	Approx. 9.5Ω	Approx. 1.9Ω	Approx. 1.5Ω
Applicable Standards	IEC 61010-1, IEC 61010-2-032, CAT III 300V Pollution degree 2, IEC 61326		
Dimensions	97(L) × 59(W) × 26(D)mm	128(L) × 81(W) × 36(D)mm	170(L) × 105(W) × 48(D)mm
Weight	Approx. 150g	Approx. 260g	Approx. 360g
Accessories	9095(Carrying case), Instruction manual, Cable marker		9094(Carrying case), Instruction manual, Cable marker
Optional	7146(Banana φ4 adjuster plug), 7185(Extension cable)		
Applicable models	5010, 5020, 5050(Cannot be used for Ior measurement.)		





# INTELLIGENT SOCKET TESTERS



# INTELLIGENT SOCKET TESTERS

**KEW 4506** **NEW**



- Easy measurement by simply plugging into a socket outlet and pressing the test button.
- In only 1 second you will check voltage, correct wiring and polarity of Line, Neutral and Earth of a socket outlet.
- KEW 4506 can be used on TT earth system and combined with KEW 8343, also on TN-S. (See Where to Use).
- Low test current measurement method for avoiding tripping of RCDs.

CE

4506				
Socket test*1				
Measurable range of power supply voltage	80V rms to 290V rms (50/60Hz) *The tester gives voltage warning if 253V or higher voltage is detected but it can perform socket test.			
Socket type	3 Pole		2 Pole	
Judgement	PASS	PASS	PASS	
		L-N Reverse	L-N Reverse	
		L-E Reverse	Abnormal voltage	
	FAIL	N-E Reverse	-	-
		E Not connected	-	-
		N Not connected	-	-
		N-E unjudgeable	-	-
Abnormal voltage	-	-		
AC V (L-N)				
Range	80 to 290V rms (50/60Hz)			
Accuracy	±2%rdg±4dgt			
Loop resistance (N-E)				
Range (Auto-ranging)	200Ω: 0.0 to 199.9Ω 2000Ω: 200 to 1999Ω			
Test current	200Ω: 5mA (5.3 Hz) 2000Ω: 1mA (5.3 Hz)			
Accuracy	±3%rdg±5dgt			
Applicable Standards	IEC 61010-1, 61010-2-030 CAT II 300V, Pollution degree 2, IEC 60529(IP40)			
Operating Temp. & humidity range	-10 - 50°C, RH 85% or less			
Storage Temp. & humidity range	-20 - 60°C, RH 85% or less			
Power source	LR6 (AA)(1.5V) × 2			
Dimensions	212(L) × 56(W) × 39(D) mm			
Weight	Approx. 250g (including batteries)			
Accessories	KAMP 10 or 7284 (Test lead with IEC connector) 9161 (Carrying case) LR6 (AA) × 2, Instruction manual			
Optional	8343 (Signal Source for Intelligent Socket Tester)			

\*1 If N-E resistance measurement function is turned off\*2, test is performed with a test voltage applied from an optional signal source only: current flows between N-E is less than 1μA.

\*2 If the function is disabled, KEW 4506 doesn't show resistance between N-E.

INTELLIGENT SOCKET TESTERS



**KAMP 10 or MODEL 7284**

Test lead with IEC connector  
KAMP10:1,500mm 7284:720mm

Applicable to the socket outlet types of each country



KAMP 10(AU) : Australian plug  
KAMP 10(EU) : European SCHUKO plug  
KAMP 10(UK) : British plug (13A)  
7284 : American(NEMA)plug



**MODEL 9161**  
Carrying case

**KEW 8343** **NEW**



CE

8343			
Conductor size	φ24mm max.		
Test voltage	Freq.	Approx. 1.8kHz	
	TRMS	Approx. 20mV rms	
Allowable input range	300V AC (50/60Hz) continuous 30A AC (50/60Hz) continuous		
Operating Temp. & humidity range	-10 - 50°C, RH 85% or less		
Storage Temp. & humidity range	-20 - 60°C, RH 85% or less		
Power source	LR6 (AA)(1.5V) × 6		
Applicable Standards	IEC 61010-1, 61010-031, 61010-2-032 CAT III 300V, Pollution degree 2, IEC 60529(IP40)		
Dimensions	Unit: 112(L) × 61(W) × 42(D) mm		
	Test voltage injection clamp: 100(L) × 60(W) × 26(D) mm		
	Cable length: Approx. 1.5m		
Weight	Approx. 520g (including batteries)		
Accessories	7157B (Alligator clips) 9096 (Carrying case) LR6 (AA) × 6, Instruction manual		

**MODEL 7157B**  
Alligator clips



**MODEL 9096**  
Carrying case



# INTELLIGENT SOCKET TESTERS

## Where to use

KEW 4506 can test the wiring connection including the N-E Reverse of single-phase socket outlets. This tester can test single phase socket outlets wired to Three-phase 4-Wire, Single-phase 3-Wire, Single-phase 2-Wire supply systems.

\*KEW 4506 cannot be used for checking three-phase socket outlets and testing the RCD.

For use in a general TN system circuit, N-E Reverse can be determined only at socket outlets connected downstream of the N conductor where KEW 8343 is clamped.

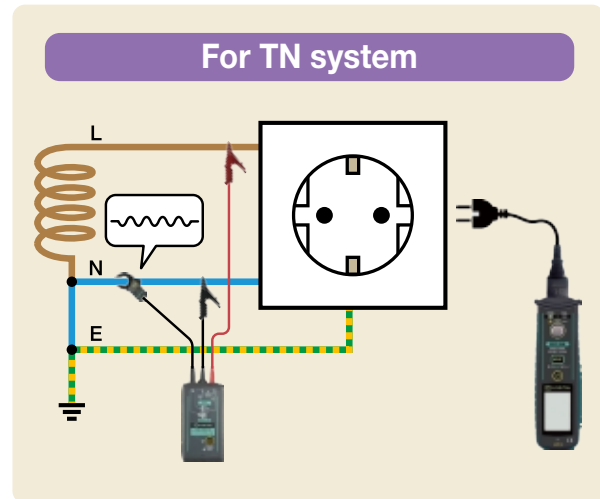
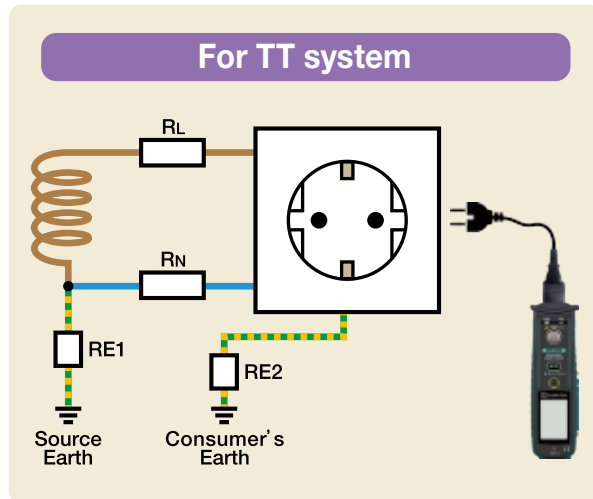

## All test results and PASS/FAIL in a clear display screen



Easy measurement by simply plugging into a socket outlet and pressing the test button.



LCD backlight automatically turns on at the dark place.

\*It is possible to disable backlight

### Wiring check with the live circuit condition

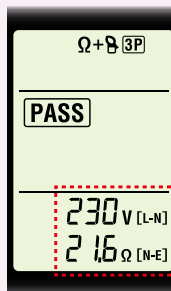

L-N voltage and N-E resistance at TT system can be displayed.

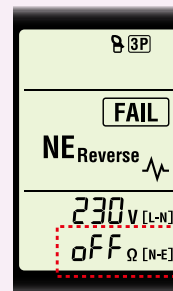

KEW 4506 has a mode which can detect the wiring connection avoiding any RCD tripping.

\*resistance measurement OFF

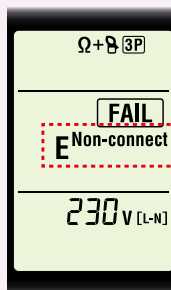

Non-connect can be also displayed.

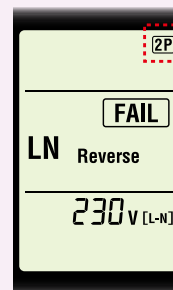

Wiring check for 2P(no earth) outlet is also available by selecting the 2P setting.

\*2P conversion adapter which is required to connect with 2P outlet, isn't supplied.

# OTHERS

## KEW 5204/5204BT

DIGITAL LIGHT METER



DATA HOLD   
5204BT  
MAX/MIN Bluetooth

photo : 5204BT

CE

- Detachable & Rotatable Light Sensor
- Data Hold Function
- MAX/MIN Function
- Large LCD with BackLight

 Wireless communication with smart-phone or tablet (Only 5204BT)



	5204/5204BT
Measuring Range	0.0 - 199900 lx
Ranges	199.9/1999/19990/199900 lx
Accuracy	±4%rdg±5dgt (23°C±2°C)
Angle deviation from cosine characteristics	10° ±1.5%, 30° ±3%, 60° ±10%, 80° ±30%
Relative spectral sensitivity characteristics	Deviation from spectral luminous efficiency:9% or less
Response time	Auto range:5s or less Manual range:2s or less
Operation Temperature/Humidity	0°C - 40°C, 80%RH or less (without condensation)
Storage Temperature/Humidity	-10°C - 60°C, 70%RH or less (without condensation)
Communication Interface	Bluetooth®5.0*, Android™ 5.0 or later, iOS 10.0 or later
Applicable Standards	IEC 61326 , JIS C 1609-1:2006
Power source	LR/R6(AA)(1.5V) × 2
Dimensions	169(L) × 63(W) × 37(D)mm
Weight	210g approx.
Accessories	9195(Carrying case) LR6(AA) × 2 Instruction Manual

\*5204BT only.  
Some countries regulate the compliance with their Radio Law of the products equipped with Bluetooth®. Please confirm it with your distributor before purchasing our products equipped with Bluetooth®.

Use the application KEW Smart Advanced to improve work efficiency.

Download and install our special application "KEW Smart Advanced" in your smartphone or tablet device for logging the measured values. Measured values can be saved in your smartphone or tablet device in csv format: the data is editable in excel format.



## MODEL 5202

DIGITAL LIGHT METER

- 3 ranges changeable from low to high illuminance. (200/2000/20000Lux)
- Data hold function.
- Digital light meter with separate light receiving sensor and meter.

CE

	5202
Ranges	0.1 - 19990Lux
Accuracy (23°C±5°C)	Lux Accuracy 200 ±4%rdg±5dgt 2000 ±4%rdg±5dgt 20000 ±5%rdg±4dgt
Current consumption	2mA approx
Response time	2.5 times / sec.
Operating temperature range	0 - 50°C Below 80% RH
Storage temperature range	-10°C - 60°C
Angular incident light characteristics	30°Less than ±3% 60°Less than ±10% 80°Less than ±30%
Power source	6F22(9V) × 1
Dimensions	Meter:148(L) × 71(W) × 36(D)mm Light receiving sensor:85(L) × 67(W) × 32(D)mm
Weight	270g approx.
Accessories	Carrying case 6F22(9V) × 1 Photocell cover Instruction manual

## KEW 5711

Voltage Detector

CAT IV 600V

- Senses AC voltage through insulation
- Buzzer sounds and tip glows upon ac voltage detection
- Powerful flashlight
- Dual range (Hi/ Lo) sensitivity
- Ready to use without power-on
- Designed to meet IEC 61010-1

CE



	5711
Operating voltage	AC 90 - 1000 V(Lo sensitivity) AC 20 - 1000 V(Hi sensitivity)
Frequency range	50/60Hz
Operating temperature	-10 - 50°C
Storage temperature	-20 - 60°C
Applicable Standards	IEC 61010-1 CAT IV 600V / CAT III 1000V Pollution degree 2
Power source	LR03 / R03(AAA)(1.5V) × 2
Dimensions	153(L) × φ20mm
Weight	Approx. 40g (including batteries)
Accessories	LR03(AAA) × 2, Instruction manual

LED light



Bright Red Indicator



# OTHERS

## KEW 8035

Non-Contact Safety Phase Indicator

CAT IV 600V



- New technology permits safe testing, without the need of direct contact between probes and live wires.
- The insulated crocodile clips can clip insulated cables from  $\phi 2.4$  to 30mm.
- Phase rotation is indicated by the rotary illumination of LEDs and logical audible tones.
- The instrument can be fixed to a metal panel via the magnet on the back side.
- Wide measuring range for 3 phase installations from 70V to 1000V AC.
- Super brightness function permits clear LEDs indication also in sunshine.

	8035
Functions	Phase rotation (Clockwise or Counter Clockwise), Presence of open phase
Detection method	Electrostatic induction
Measuring voltage range	From 70 - 1000V AC phase to phase (sine wave, continuous input)
Clamp diameter range	From $\phi 2.4$ to 30mm insulated cables
Measuring frequency range	45 to 66Hz
Phase rotation	Clockwise: Green arrow LEDs "rotate" in clockwise, Green symbol "CW" lits, Intermittent buzzer Counter Clockwise: Red arrow LEDs "rotate" in counter clockwise, Red symbol "CCW" lits, continuous buzzer
Visual indication	Via LEDs with Super brightness function
Battery voltage warning	Power LED blinks if battery voltage is too low.
Operating temperature & humidity range	-10 - 50°C, relative humidity 80% or less (no condensation)
Storage temperature & humidity range	-20 - 60°C, relative humidity 80% or less (no condensation)
Applicable Standards	IEC 61010-1 CAT IV 600V, CAT III 1000V Pollution degree2
Power source	LR6(AA)(1.5V) $\times$ 4 * Continuous use: Approx. 100 hours (Auto power off in about 10 min.)
Dimensions	112(L) $\times$ 61(W) $\times$ 36(D) mm
Weight	380g approx.
Test leads	Double insulated cables, length approx. 70cm
Colours code	L1(U): Red L2(V): White L3(W): Blue
Accessories	9096 (Carrying case), LR6(AA) $\times$ 4, Instruction manual

## KEW 8031 <sup>NEW</sup> / 8031F

PHASE INDICATOR with open phase checker

PHASE INDICATOR with fused test leads



photo : 8031F

KEW 8031 CE type

KEW 8031 Standard type

	8031		8031F
	Standard Type	CE Type	
Operational voltage	110 - 600V AC		
Fuse	—		0.5A/600V (F)
Time limit for continuous	>500V : within 5 minutes		
Frequency response	50/60Hz		
Applicable Standards	—		IEC 61010-1 CAT IV 300V, CAT III 600V Pollution degree 2
Dimensions	106(L) $\times$ 75(W) $\times$ 40(D)mm		
Weight	350g approx.		
Cord	1.5m(R : red S : white T : blue)		1.3m(R:red S:white T:blue)
Accessories	9029(Carrying case) Instruction manual		8923(Fuse [0.5A/250V]) 9094(Carrying case) Instruction manual

- Phase indicator designed to check the presence of open phase and also the phase sequence by rotating disk and lamps.
- Can check a wide range of 3-phase power source from 110V to 600V. Sealed against dust, the unit ensures trouble-free performance.
- Small, Lightweight and portable. Designed for maximum ease of operation and ruggedness.
- No exposed metal parts, Safety features are incorporated including the instant push button switch operation.(8031F Only)

## KEW 5515

Infrared Thermometer



- Single laser allows more accurate measurements.
- Back light display helps to read in a dark place.
- Dual display: Main display shows the measured values and Sub display shows either of max, min, average or thermocouple value.
- Alarm function: The upper and lower temperature limits can be set.
- The red blinking back light indicates that the measured value is below or over the pre-set limits.

	5515
Measuring range	-32 - 535°C
Accuracy	$\pm 3.0^\circ\text{C}$ (-32 - -20 °C), $\pm 2.0^\circ\text{C}$ (-20 - +100°C), $\pm 2\% \text{rdg}$ (100 - 535°C)
Infrared spectral band	5 - 14 $\mu\text{m}$
Measuring diameter	1000mm/ $\phi 78\text{mm}$ (Distance/ Measuring dia.: 12:1)
Repeatability	Within $\pm 1^\circ\text{C}$
Emissivity	Variable between 0.10 and 1.00 (by 0.01 steps), Before shipment: 0.95
Collimation	Laser beam (630 - 670nm 1mW or less) specifies the center.
Thermocouple	K-type*
Measuring range of thermocouple	-199 - 1372°C
Accuracy of thermocouple	$\pm 1.5\% \text{rdg} + 1^\circ\text{C}$ (-40 - 1372°C)
Response	500ms
Resolution	0.1°C
Auto power off	If no key is pressed for 6 seconds, the power is shut off automatically.
LCD display	LCD with back light (blinks in red when alarm function is activated)
Dual display	Simultaneous display (Measured value and either of max, min, average or thermocouple value.)
Operating temperature & humidity	0 - 50°C / 10 - 90% RH
Applicable Standards	IEC 61326, IEC 61000-4-2, IEC 61000-4-3, IEC 61000-4-8
Power source	6F22(9V) $\times$ 1
Dimension	180(L) $\times$ 130(W) $\times$ 40(D)mm
Weight	Approx. 195g (excluding battery)
Accessories	9152(Carrying case), 6F22(9V) $\times$ 1 Instruction manual

\*Commercial K-type thermocouple can be used with the product.



## KT 200

### AC CLAMP METER

Ø30 MAX 400A AC A DC AC V Ω ●●)

DATA HOLD AUTO POWER SAVE

- Small and handy clamp meter
- IEC 61010-1 Safety Standard CAT III 300V, CAT II 600V
- 400A AC Clamp meter
- DMM function ACV, DCV, Ω Continuity Buzzer.

	KT 200
AC A	40.00/400.0A ±2.0%rdg±6dgt(50/60Hz)
AC V	400.0/600V(Auto-ranging) ±2.0%rdg±5dgt(50/60Hz)
DC V	400.0/600V(Auto-ranging) ±1.5%rdg±5dgt
Ω	400.0/4000Ω(Auto-ranging) ±2.0%rdg±5dgt
Continuity buzzer	buzzer sounds below 50±35Ω
Conductor size	φ30mm max.
Applicable Standards	IEC 61010-1 CAT III 300V(ACA), CAT II 600V Pollution degree 2 IEC 61010-2-032, IEC 61326-1
Power source	R03(1.5V)(AAA) × 2 *Continuous measuring time:approx.200 hours(Auto power save: approx.10 minutes)
Dimensions	184(L) × 68.6(W) × 38.5(D)mm
Weight	Approx. 190g(including batteries)
Accessories	7066A(Test leads), R03(AAA) × 2, Instruction manual
Optional	9105(Carrying case)

CE



## KT 203

### AC/DC CLAMP METER

Ø30 MAX 400A DC AC A DC AC V Ω ●●)

DATA HOLD AUTO POWER SAVE

- Small and handy clamp meter
- IEC 61010-1 Safety Standard CAT III 300V, CAT II 600V
- 400A AC/DC Clamp meter
- DMM function ACV, DCV, Ω Continuity Buzzer.

	KT 203
AC A	40.00/400.0A (Auto-ranging) ±3.0%rdg±8dgt[50/60Hz](0 - 40.00A) ±3.5%rdg±6dgt[50/60Hz](15.0 - 299.9A) ±4.0%rdg±6dgt[50/60Hz](300.0 - 400.0A)
DC A	40.00/400.0A (Auto-ranging) ±3.0%rdg±8dgt (0 - 40.00A) ±3.5%rdg±6dgt (15.0 - 299.9A) ±4.0%rdg±6dgt (300.0 - 400.0A)
AC V	400.0/600V(Auto-ranging) ±2.0%rdg±5dgt(50/60Hz)
DC V	400.0/600V(Auto-ranging) ±1.5%rdg±5dgt
Ω	400.0/4000Ω(Auto-ranging) ±2.0%rdg±5dgt
Continuity buzzer	buzzer sounds below 50±35Ω
Conductor size	φ30mm max.
Applicable Standards	IEC 61010-1 CAT III 300V(ACA), CAT II 600V Pollution degree 2 IEC 61010-2-032, IEC 61326-1
Power source	R03(1.5V)(AAA) × 2 *Continuous measuring time:approx.35 hours(Auto power save: approx.10 minutes)
Dimensions	187(L) × 68.5(W) × 38.5(D)mm
Weight	Approx. 200g(including batteries)
Accessories	7066A(Test leads), R03(AAA) × 2, Instruction manual
Optional	9105(Carrying case)

CE

## KT 170/171

VOLTAGE TESTERS

CAT IV  
600V



CE

CE

photo : KT170

photo : KT171

Probe Protection Cover



KT170/171	
Voltage test	
Voltage range	12 - 690V AC/DC
LED	
Nominal voltage	12/24/50/120/230/400/690V AC(16 - 400Hz), DC(±)
Tolerance (Threshold voltage)	Light on at more than: 7±3V (12V LED) 18±3V (24V LED) 37.5±4V (50V LED) 75%±5% of nominal voltage (120/230/400/690V LED)
Response time	< 0.6s at 100% of each nominal voltage
LCD (KT171 only)	
Range / Resolution (Auto-range)	300V AC/DC (6.0 - 299.9) / 0.1V 690V AC (270 - 759) / 1V 690V DC (270 - 710) / 1V
Accuracy (23±5°C)	±1.5V (7 - 100V) ±1%±5dgt (100 - 690V) AC(16 - 400Hz), DC(±)
Over limit indication	"OL"
Response time	Approx. 1s at 90% - 100% of each voltage
Peak current	Is<3.5mA (at 690V)
Measurement Duty	30s ON (operation time) 240s OFF (recovery time)
Single-pole phase test	
Voltage range	100 - 690V AC (50/60Hz)
Phase rotation test	
System	Three-phase 4-wire system 200 - 690V phase-to-phase AC (50/60Hz)
Phase range	120±5 degree
Continuity test	
Detection range	0 - 400kΩ + 50%
Test current	Approx. 1.5µA (battery 3V, 0Ω)
Operating temperature and humidity ranges	-15 - 55°C, max 85% RH (No condensation)
Storage temperature and humidity ranges	-20 - 70°C, max 85% RH (No condensation)(KT170) -20 - 60°C, max 85% RH (No condensation)(KT171)
Applicable Standards	IEC 61243-3, IEC 61010-1, IEC 61557-7 CAT IV 600V / CAT III 690V Pollution degree 2, IEC 60529 (IP65)
Power source	LR03(AAA) (1.5V) × 2
Dimensions	246(L) × 64(W) × 26(D)mm
Weight	195g (including batteries)
Accessories	LR03(AAA) × 2, KTA01(4mm metal tips[2pcs/set]), KTA02(4mm rubber caps[2pcs/set]), Instruction manual

KT170AU is available for Australia and New Zealand market.

- Comply with the latest standards IEC 61243 and IEC 61010
- Novel design  
Large and bright LEDs: Values are visible in the dark place.  
Ergonomic design fits in the hand.
- Two functions are available in one model.  
"Measurement without battery" and "Self Test (all LED on)"
- Test leads withstand harsh environments at low temperature.
- Penlight(white LED)
- Auto-power ON / OFF
- Audible indication
- Variable test tips, φ2mm or φ4mm
- Probe protection cover can store the attachment of caps.
- IP65 (IEC 60529)

### Variable top tips

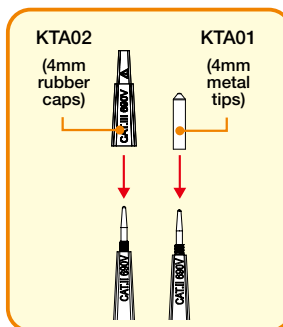

### Store the attachment of caps

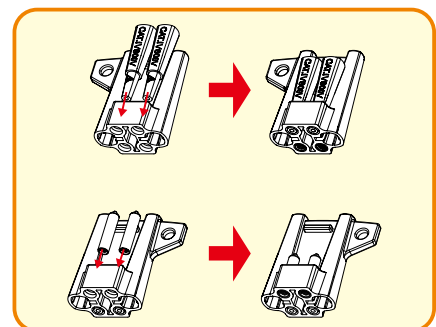

### Voltage Test (Double-pole Test)

- The voltage is indicated by LEDs.
- Buzzer sounds and Live circuit LED lights up when a threshold voltage of 50V is exceeded.
- Voltage polarity is indicated in following manner.



AC +DC -DC

### Bright LEDs and Penlight



### Single-pole Phase Test



# ACCESSORIES

## 7025

1,500mm



Applicable model

3165  
3166



Plug  $\phi 4$

## 7066A

1,100mm



Applicable model

1009 2046R  
1011 2055  
1012 2056R  
1020R 2117R  
1021R 2127R  
1109S KT200  
1110 KT203  
2007R



Plug  $\phi 4$

## 7073

2,120mm

\*2WAY Output cord



Applicable model

2413F  
2413R



Plug  $\phi 4$

## 7082

1,100mm

\*Lead for recorder



Applicable model

3124A



Plug  $\phi 4$

## 7083

5,200mm

\*Lead for battery charging



Applicable model

3124A

## 7084

5,000mm

\*Earth and guard leads



Applicable model

3124A



Plug  $\phi 4$

## 7095A

\*Earth resistance test leads



Applicable model

4102A  
4105A  
6018

Green: 5m  
Yellow: 10m  
Red: 20m



Plug  $\phi 4$

## 7103A/7139A

Line 1,000mm Earth 1,550mm

\*Test leads with remote control switch

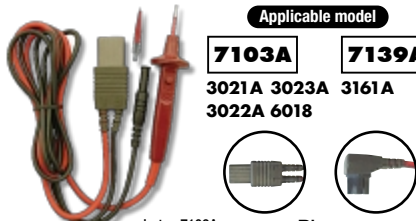

Applicable model

**7103A** **7139A**  
3021A 3023A 3161A  
3022A 6018

photo : 7103A

Plug

## 7107A

1,100mm

Applicable model

2002PA  
2002R  
2003A  
2009R  
2200  
2200R



Plug  $\phi 4$

## 7121B

1,500mm

\*Distribution board test leads



Applicable model

4118A  
5406A



Plug

## 7122B/7217A

1,220mm

Applicable model

**7122B** **7217A**  
3005A 3132A 3132A  
3007A 6010B  
3131A 6011A

7217A :  
For Australia



Plug  $\phi 4$

photo : 7122B

## 7123/7124/7125/7126

1,500mm

\*Molded plug test lead



photo : 7123

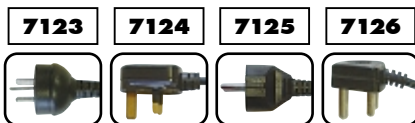

Plug

7123 : (AU) Australian plug  
7124 : (UK) British plug (13A)  
7125 : (EU) European SCHUKO plug  
7126 : (SA) South african plug

Applicable model

4118A  
5406A

## 7127B

1,570mm

\*Simplified measurement probe



Applicable model

4102A 4105DL  
4105A



Plug  $\phi 4$



# ACCESSORIES

**7128A** 1,390mm



Applicable model  
5410



Plug  $\phi 4$

**7129A** 1,450mm



Applicable model  
5410  
6205

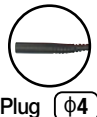

Plug  $\phi 4$

**7132A** 1,200mm  
(KSLP5)



Applicable model  
6011A



Plug  $\phi 4$

**7133B** 1,500mm  
(OMA DIEC)



Applicable model  
6010B  
6011A

**7141B** 3,000mm

\*Voltage test lead set



Applicable model  
6305  
6315

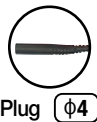

Plug  $\phi 4$

**7146** 190mm

\*Banana  $\phi 4$  adjuster plug



Applicable model  
8121 8127  
8122 8128  
8123 8146  
8124 8147  
8125 8148  
8126



Plug  $\phi 4$

**7148** 2,000mm

\*USB cable



Applicable model  
5010  
5020  
6305

**7149A/7150A** Line 1,000mm Earth 1,550mm

\*Test leads with remote control switch set



photo : 7149A

Applicable model

7149A	7150A
3161A	3021A
	3022A
	3023A
	6018



7149A Consists of:  
7139A(Test leads with remote control switch)  
7161A(Flat test prod [black])  
7131B(Safety crocodile clip [black])  
8017(Extension prod)  
8072(CAT II Standard prod)  
8256(Extension prod)  
9041(Cord case)

7150A Consists of:  
7103A(Test leads with remote control switch)  
7161A(Flat test prod [black])  
7131B(Safety crocodile clip [black])  
8017(Extension prod)  
8072(CAT II Standard prod)  
8256(Extension prod)  
9120(Cord case)

**7153B** 1,220mm

\*Safety test leads



Applicable model  
1009 2046R  
1011 2055  
1012 2056R  
1021R 2117R  
1110 2127R  
2007R



Plug  $\phi 4$

**7154B** 1,220mm

\*Safety test leads



Applicable model  
1009 2117R  
1011 2127R  
1012 3165  
1021R 3166  
1110 6010B  
2007R 6011A  
2046R  
2055  
2056R



Plug  $\phi 4$

**7155B**

\*Safety crocodile clips with fuse



Applicable model  
7153B  
7154B

**7156B** 1,220mm

\*Safety test leads with fuse



Applicable model  
1009 2117R  
1011 2127R  
1012 3165  
1021R 3166  
1110 6010B  
2007R 6011A  
2046R  
2055  
2056R



Plug  $\phi 4$

**7157B/7158B**

Applicable model  
7153B 7154B  
8343



photo : 7157B

Applicable model  
7155B 7156B



photo : 7158B

**7159B** 1,220mm

\*Safety test leads with fuse



Applicable model  
1009 2117R  
1011 2127R  
1012 3165  
1021R 3166  
1110 6010B  
2007R 6011A  
2046R  
2055  
2056R



Plug  $\phi 4$

# ACCESSORIES

## 7165A 3,000mm

\*Line probe



Applicable model

3025A  
3121B  
3122B  
3123A  
3125A  
3127

## 7168A 3,000mm

\*Line probe with alligator clip



Applicable model

3025A  
3121B  
3122B  
3123A  
3125A  
3127

## 7170

2,000mm

\*Power cord



Applicable model

3128  
6305  
6315

## 7185

3,000mm

\*Extension cable



Applicable model

5010 8128  
5020 8146  
8121 8147  
8122 8148  
8123  
8124  
8125  
8126  
8127

## 7187A/7218A/7221A/7222A

1,230mm

\*Main test lead



photo: 7218A

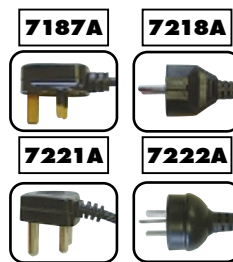
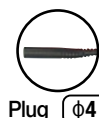

Applicable model

4140  
6516  
6516BT

7187A: UK plug  
7218A: EU plug  
7221A: SA plug  
7222A: AU plug

## 7196B

1,550mm

\*Test leads with remote control switch



Applicable model

6024PV

## 7219

1,950mm

\*USB cable



Applicable model

5050  
6315

## 7220A

1,080mm



Applicable model

1051  
1052  
1061  
1062



## 7224A

1,500mm

\*Earth cord



Applicable model

3123A  
3127  
3128

## 7225A

1,500mm

\*Guard cord



Applicable model

3123A  
3127  
3128

## 7226A

3,000mm

\*Line probe



Applicable model

3128

## 7227A

3,000mm

\*Line probe with alligator clip



Applicable model

3128

## 7228A

\*Earth resistance test leads



Applicable model

6516 6516BT

Green: 5m  
Yellow: 10m  
Red: 20m

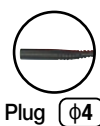

## 7229A

\*Earth resistance test leads



Applicable model

4106  
Green: 20m  
Yellow: 20m  
Black: 20m  
Red: 40m



# ACCESSORIES

## 7234

1,080mm

\*Alligator clip



Applicable model

1009 1051  
1011 1052  
1012 1061  
1020R 1062  
1021R



Plug  $\phi 4$

## 7238A

1,570mm

\*Simplified measurement test leads



Applicable model

4106



Plug  $\phi 4$

## 7243A

1,650mm

\*L-shaped probe



Applicable model

3431  
3551  
3552  
3552BT  
6024PV

## 7244A

1,400mm



Applicable model

6024PV



Plug  $\phi 4$

## 7245A



Consists of :  
7228A(Earth resistance test leads)  
8032(Auxiliary earth spikes[2 spikes/set])  
8200-03(Cord reels[3 pcs])  
9142(Carrying case)

Applicable model

4102A  
4105A  
6018  
6024PV

Green : 5m  
Yellow : 10m  
Red : 20m

## 7246

1,400mm

\*Distribution board test lead



Applicable model

4140  
6516  
6516BT



Plug  $\phi 4$

## 7247

1,400mm

\*Distribution board test lead



photo : 7246

Applicable model

4140



Plug  $\phi 4$

## 7248

2,000mm



Applicable model

4300  
6205



Plug  $\phi 4$

## 7253/7254

15m

\*Longer line probe with alligator clip



photo : 7253

Applicable model

**7253**

3121B 3025A  
3122B 3125A  
3123A 3127

**7254**

3128

## 7256

1,200mm

\*Out put cord



Applicable model

2002PA 2010  
2002R 2500  
2003A 2510  
2009R



Plug  $\phi 4$

## 7260

1,400mm

\*Test leads with remote control switch



Applicable model

3431  
3551  
3552  
3552BT

## 7261A

2,000mm



Applicable model

3431  
3551  
3552  
3552BT



Plug  $\phi 4$

## 7264

3,000mm

\*Earth cord



Applicable model

3025A  
3121B  
3122B  
3125A

## 7265

3,000mm

\*Guard cord



Applicable model

3025A  
3121B  
3122B  
3125A

## 7266

\*Earth resistance test leads



Applicable model

4105DL

Green: 5m  
Yellow: 10m  
Red: 20m



Plug  $\phi 4$

# ACCESSORIES

## 7267/7268

\*Cable reel for Earth resistance tester

Applicable model  
4105DL



**7267**

Red: 20m

**7268**

Yellow: 10m

## 7269 20m

\*Earth resistance test lead (Red)

Applicable model  
4105DL



Plug  $\phi 4$

## 7270 10m

\*Earth resistance test lead (Yellow)

Applicable model  
4105DL



Plug  $\phi 4$

## 7271 5m

\*Earth resistance test lead (Green)

Applicable model  
4105DL



Plug  $\phi 4$

## 7272

\*Precision measurement Cord set

Applicable model  
4105DL



Consists of:  
7267(Cable reel for Earth resistance tester (Red))  
7268(Cable reel for Earth resistance tester (Yellow))  
7271(Earth resistance test lead (Green))  
8041(Auxiliary earth spikes(2 spikes/1set))  
9192(Carrying case for cord reels)

Green: 5m  
Yellow: 10m  
Red: 20m

## 7273 3,000mm

\*Voltage test leads

Applicable model  
5050



Plug  $\phi 4$

## 7275 2,000mm

\*Printer Cable

Applicable model  
6205



## 7276 400mm

\*Extension leads adaptor

Applicable model  
6205



## 7277 1,440mm

\*Mains Lead

Applicable model  
6205



## 7278 1,500mm

\*Earth Cable

Applicable model  
5050



## 7281 1,400mm

\*Test leads with remote control switch

Applicable model  
6516  
6516BT



## 7284 720mm

\*Test Lead with IEC Connector

Applicable model  
4506



American (NEMA) plug

## 7290 1,500mm

\*Voltage test lead set

Applicable model  
2060BT  
2062  
2062BT



Plug  $\phi 4$

## KAMP10 1,500mm

\*Test lead with IEC connector

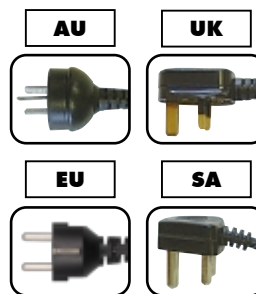

Plug

Applicable model  
4506  
6010B  
6011A

AU : Australian plug  
UK : British plug (13A)  
EU : European SCHUKO plug  
SA : South african plug

\*SA plug is not included in the accessories of KEW 4506.

# ACCESSORIES

## 8216 1,000mm

\*Temperature probe

Applicable model

1011  
2046R  
2056R

• -50°C - 300°C



## 8405 1,400mm

\*Temperature probe

Applicable model

1051 1061  
1052 1062

• -40°C - 500°C, Surface type,  
Point material: Ceramic



Plug  $\phi 4$



## 8406 1,380mm

\*Temperature probe

Applicable model

1051 1061  
1052 1062

• -40°C - 500°C, Surface type



Plug  $\phi 4$



## 8407 1,540mm

\*Temperature probe

Applicable model

1051 1061  
1052 1062

• -40°C - 700°C, Liquid,  
Semi-solid



Plug  $\phi 4$



## 8408 1,540mm

\*Temperature probe

Applicable model

1051 1061  
1052 1062

• -40°C - 600°C, Air, Gas



Plug  $\phi 4$



## 8901

Fuse [0.5A/250V]

Applicable model

1109S



## 8918

Ceramic fuse [0.8A/600V]

Applicable model

1011  
1012



## 8919

Ceramic fuse [10A/600V]

Applicable model

1009  
1011  
1012  
1021R  
7133B  
7155B  
7156B  
7159B



## 8923

Fuse [0.5A/600V]

Applicable model

1009 4106  
1110 6010B  
3005A 6011A  
3007A 8031F  
3021A 8312  
3022A 8329  
3023A  
3131A  
3132A



## 8926

Fuse [440mA/1000V]

Applicable model

1051  
1052  
1061  
1062



## 8927

Fuse [10A/1000V]

Applicable model

1051  
1052  
1061  
1062



## 8928

Fuse [10A/250V]

Applicable model

6205



Scan QR code and get more info about Accessory.

## Accuracy

The accuracy of a digital tester is defined as the difference between the reading and the true value for a quantity measured in reference conditions. Accuracy is specified in the format: ( $\pm xx\%$  rdg  $\pm xx$  dgt)

The first portion identifies a percentage error relative to the reading, which means it is proportional to the input. The second portion is an error, in digits, that is constant regardless of the input.

"Rdg" is for reading and "dgt" is for digits. Dgt indicates the counts on the last significant digit of the digital display and is typically used to represent an error factor of a digital tester.

## Auto-discharge Function

A function used immediately after an insulation test to automatically release charges stored within the circuit under test during measurement.

Voltage remaining in the circuit under test can be monitored during auto-discharging process by the showing display.

## Auto-ranging

A function of a tester to automatically select the appropriate measuring range based on the input signal.

## Average Value

The average of an AC waveform's instantaneous values taken over a half cycle. Ordinary testers respond to the average value.

For sinusoidal wave :

Average value = Maximum value  $\times 2/\pi$  = Maximum value  $\times 0.637$

When the true RMS value is 100V ;

Average value = Maximum value  $\times 2/\pi$  =  $141 \times 0.637 = 90(V)$

The reading of ordinary testers is calibrated in terms of the effective value of a sinusoidal wave even though they are responding to the average value. They are called average-responding-RMS-calibrated type of testers. As opposed to these, true-RMS type testers respond and show the true RMS value.

## Crest Factor

The ratio of the maximum value to the effective value.

It represents the range of input in which a tester maintains linear operation, expressed by a multiple of the full scale value of the range being used.

Crest factor = Maximum value/True RMS value

For sinusoidal wave;

Crest factor =  $141/100 = 1.41$

## Data Hold

A function to freeze the reading on a digital display for ease of checking or recording even in a difficult-to-read situation for a tester.

## Decibel: dB

A unit used to express the magnitude of change in level of electric signal or sound intensity.

A voltage ratio of 1 to 10 is equal to -20dB, 10 to 1 to 20dB, 100 to 1 to 40dB and 1000 to 1 to 60dB. A power ratio of 10 to 1 is not 20dB, but 10dB, since power(P) is proportional to the square of voltage(V).

## Diode Test

A function to apply a diode or a transistor a constant current having a value needed to turn it on in order to check the diode's or the transistor's forward voltage drop and identifying the connection direction of the device.

## Distortion Factor

A degree of distortion of a waveform, typically expressed as the ratio of the effective value of harmonic components to the effective value of the fundamental component.

## Dual Integration Method

A technique to convert voltage into time. The first integration time (Ts) and the second integration time (Tx) are used. First, the input voltage (Vx) is integrated on a certain time interval (Ts) and then, the resulting voltage is "reverse-integrated" using a reference voltage (Vr) until it becomes 0 (zero).

The "reverse-integration time" (Tx) is proportional to input voltage (Vx). Therefore, the input voltage (Vx) can be determined by measuring Tx.

With this technique, stable measurements can be taken with high accuracy, resolution and noise rejection ratio. One particular advantage is high noise rejection ratio at 50 or 60Hz power line frequency.

## Effective Measuring Range of Insulation Tester

The measuring range for which the accuracy of an insulation tester is guaranteed. There are two kinds of effective measuring ranges: the first and second effective measuring ranges.

### First effective measuring range

From 1/1000 to 1/2 the maximum effective scale value (When there is no major scale division for 1/2 the maximum effective scale value, the nearest major scale division is used.) (except for 3431, 3021A series)

### Second effective measuring range

Scales divisions not included in the first effective measuring range  
For example for a 500V/100M $\Omega$  insulation tester;  
First effective measuring range: 0.1-50M $\Omega$ ( $\pm 5\%$  of indicated value)  
Second effective measuring range: other than above, 0 and  $\infty$  ( $\pm 10\%$  of indicated value)

## Form Factor

The ratio of the effective value to the average value.

Form factor = Effective value/Average value

## Frequency Response

The manner in which a device changes its output quantity it, its indication for a measured quantity or its response over a range of frequencies.

AC signals to measure with a tester can be of one frequency or from a wide frequency band ranging from low to high frequencies. To measure these frequencies, it is better to use a tester having a wide frequency response range.

## Hall Element

When a current-carrying conductor is placed in a magnetic field so that the direction of the magnetic field is perpendicular



# GLOSSARY

to the direction of the current flow, voltage is developed in the direction perpendicular to both the magnetic field and the current flow. This is called the Hall effect and the Hall element is a device that utilizes the effect.

Almost all of the Kyoritsu AC/DC clamp meters and clamp sensors employ the Hall element.

## Harmonics

Power line AC voltage from a utility company has near sinusoidal waveform of fundamental frequency with little distortion. When only a load consisting of resistors, capacitors and coils, called a linear load (its constant is fixed regardless of the amount of current flowing through it), is connected to mains supply, no distortion is introduced into the load current waveform. However, when a non-linear load, such as a semiconductor and a saturable reactor, is connected, distortion appears in the load current waveform. The current with a waveform containing distortion, or harmonic current, flows in the direction toward the low impedance side and in the process, produces voltage drop over the impedance of the current path, causing the load voltage also to contain harmonics.

## Indicated Value

The value indicated by a tester for a measured quantity

## Peak Hold

A function to memorize the peak value over a certain period of time.

\*Response time is normally approx. 10ms.

Reading in the peak hold mode are two types. (the peak of current crest value and the peak current value multiplies by  $1/\sqrt{2}$ )

## Peak Value

The value at a point where a waveform has the maximum amplitude.

## Resolution

The minimum increments in which a tester can take measurements.

## Sample Rate

Frequency at which an A/D converter circuit senses the quantity to measure: typically, twice or three times per second.

## Sensitivity

The ability of a tester to respond to the quantity to measure, expressed as the ratio of a change induced in the reading to a change in the input:

$$\text{Sensitivity} = \frac{\text{Change in reading}}{\text{Change in quantity to measure}}$$

## Shock Hazard

Also referred to as electric shock. When a person touches a motor that has a "leak", a path can be created from the motor frame to the hand, body and feet of the person to the floor he is standing on to allow a current to flow through it, sometimes resulting in a fatal accident.

The seriousness of a shock hazard widely varies depending on the amount and duration of the current that flows through the person's body. His constitution, age and medical condition are also variation factors, but in general, at a frequency of 50 or 60Hz, stimulus to the skin is felt at 1mA, considerable pain occurs at 5mA, pain is unbearable at 10mA, there is difficulty in releasing the "leaking" object because of intense muscle contraction at 20mA, it is considerably dangerous at 50mA and fatality is likely at 100mA. For the safety limit for a fatal current, which causes ventricular fibrillation, Professor Dalziel proposed the following equation from numbers of experiments on animals.

$$I = 165 \sqrt{t}$$

Where, I = current (mA) and t = time (sec).

From this theory, the maximum duration for a current of 165mA is 1 second.

## Thermocouple

A device that uses the voltage developed by the junction of two dissimilar metals to measure temperature. One junction, called the measuring junction, is placed at the point where temperature is to be measured. The other junction, called the reference junction, is maintained at a reference temperature. The voltage developed between the two junctions varies depending on the difference between the temperatures of the two junctions and the type of thermocouple.

## True RMS Value

The square root of the average of the square of a periodic waveform's instantaneous values taken over one cycle. It is also called the rms value and the most closely relates to such form of energy as force and heat.

(The effective value of an alternating current is expressed as the value of the direct current which produces the same amount of heat as the alternation current does.)

For sinusoidal wave :

$$\text{True RMS} = \text{Maximum value} \times 1/\sqrt{2} = \text{Maximum value} \times 0.707$$

When a True RMS is 100V ;

$$\text{Maximum value} = \text{True RMS} \times \sqrt{2} = 100 \times 1.41 = 141(\text{V})$$

## Measurement categories

To ensure safe operation of measuring instruments, IEC 61010 establishes safety standards for various electrical environments, categorized as O to CAT IV, and called measurement categories. Higher-numbered categories correspond to electrical environments with greater momentary energy, so a measuring instrument designed for CAT III environments can endure greater momentary energy than one designed for CAT II.

O : Measuring circuits without a MEASUREMENT CATEGORY.

CAT II : Electrical circuits of equipment connected to an AC electrical outlet by a power cord.

CAT III : Primary electrical circuits of the equipment connected directly to the distribution panel, and feeders from the distribution panel to outlets.

CAT IV : The circuit from the service drop to the service entrance, and to the power meter and primary overcurrent protection device (distribution panel).

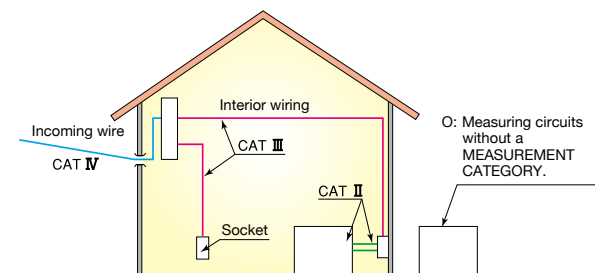

# PRODUCT INDEX

1000		
1009	Digital Multimeter	12
1011	Digital Multimeter	12
1012	Digital Multimeter	12
1019R	Digital Multimeter	13
1020R	Digital Multimeter	11
1021R	Digital Multimeter	11
1030	Digital Multimeter (Pen type)	13
1051	Digital Multimeter	14
1052	Digital Multimeter	14
1061	Digital Multimeter	14
1062	Digital Multimeter	14
1109S	Analogue Multimeter	12
1110	Analogue Multimeter	12

2000		
2000A	Digital Multimeter	16
2001A	Digital Multimeter	16
2002PA	Digital Clamp Meter	20
2002R	Digital Clamp Meter	20
2003A	Digital Clamp Meter	23
2007R	Digital Clamp Meter	20
2009R	Digital Clamp Meter	23
2010	Digital Clamp Meter	23
2012RA	Digital Multimeter	16
2031	Digital Clamp Meter	20
2033	Digital Clamp Meter	24
2046R	Digital Clamp Meter	24
2055	Digital Clamp Meter	24
2056R	Digital Clamp Meter	24
2060BT	Clamp Power Meter	61
2062	Clamp Power Meter	61
2062BT	Clamp Power Meter	61
2117R	Digital Clamp Meter	21
2127R	Digital Clamp Meter	21
2200	Digital Clamp Meter	21
2200R	Digital Clamp Meter	21
2204R	Digital Clamp Meter	22
2210R	Digital Clamp Meter	22
2300R	Fork Current Tester	27
2413F	Leakage Clamp Meter	27
2413R	Leakage Clamp Meter	27
2431	Leakage Clamp Meter	26
2432	Leakage Clamp Meter	26
2433	Leakage Clamp Meter	26
2433R	Leakage Clamp Meter	26
2434	Leakage Clamp Meter	27
2500	DC Milliamp Clamp Meter	25
2510	DC Milliamp Clamp Logger	25

3000		
3005A	Digital Insulation/Continuity Tester	32
3007A	Digital Insulation/Continuity Tester	32
3021A	Digital Insulation/Continuity Tester	32
3022A	Digital Insulation/Continuity Tester	32
3023A	Digital Insulation/Continuity Tester	32
3025A	High Voltage Insulation Tester	39
3121B	High Voltage Insulation Tester	37
3122B	High Voltage Insulation Tester	37
3123A	High Voltage Insulation Tester	38
3124A	High Voltage Insulation Tester	38
3125A	High Voltage Insulation Tester	39
3127	High Voltage Insulation Tester	40
3128	High Voltage Insulation Tester	41
3131A	Analogue Insulation/Continuity Tester	34

3132A	Analogue Insulation/Continuity Tester	34
3161A	Analogue Insulation Tester	35
3165	Analogue Insulation Tester	35
3166	Analogue Insulation Tester	35
3431	Analogue Insulation Tester	35
3551	Digital Insulation/Continuity Tester	33
3552	Digital Insulation/Continuity Tester	33
3552BT	Digital Insulation/Continuity Tester	33

4000		
4102A	Earth Tester (Soft case model)	45
4102A-H	Earth Tester (Hard case model)	45
4105A	Earth Tester (Soft case model)	45
4105A-H	Earth Tester (Hard case model)	45
4105DL	Earth Tester (Cable reel set model)	44
4105DL-H	Earth Tester (Hard case model)	44
4106	Earth Tester	46
4118A	LOOP/PSC Tester	48
4140	LOOP/PFC/PSC Tester	49
4200	Earth Clamp Tester	47
4202	Earth Clamp Tester	47
4300	Simplified Earth Tester	46
4506	Intelligent Socket Tester	74

5000		
5010	AC Current Logger	66
5020	AC Current/Voltage Logger	66
5050	Ior Logger	68
5050-01	5050-00 + 8178 × 1	69
5050-02	5050-00 + 8177 × 1	69
5202	Digital Light Meter	76
5204	Digital Light Meter	76
5204BT	Digital Light Meter	76
5406A	RCD Tester	50
5410	RCD Tester	50
5515	Infrared Thermometer	77
5711	Voltage Detector	76

6000		
6010B	Multi Function Tester	56
6011A	Multi Function Tester	57
6018	Multi Function Tester	57
6024PV	PV Insulation Earth Tester	58
6205	Portable Appliance Tester	52
6305	Power Meter	62
6305-01	6305 + 8125 × 3 + 9125	63
6305-03	6305 + 8130 × 3 + 9135	63
6305-05	6305 + 8133 × 3 + 9135	63
6315	Power Meter	64
6315-01	6315 + 8125 × 3 + 9125	65
6315-03	6315 + 8130 × 3 + 9135	65
6315-04	6315 + 8130 × 4 + 9135	65
6315-05	6315 + 8133 × 3 + 9135	65
6516	Multi Function Tester	54
6516BT	Multi Function Tester	54

7000		
7025	Test leads	35,80
7066A	Test leads	11,12,20,21,24,78,80
7073	2WAY Output cord	27,80
7082	Leads for recorder	38,80
7083	Leads for battery charging	38,80
7084	Earth and guard leads	38,80
7095A	Earth resistance test leads	45,80
7103A	Test leads with remote control switch	57,80





# PRODUCT INDEX

7107A	Test leads	20,21,23,80
7121B	Distribution board test leads	48,50,80
7122B	Test leads	32,34,56,57,80
7123	Molded plug test lead [AU]	48,50,80
7124	Molded plug test lead [UK]	48,50,80
7125	Molded plug test lead [EU]	48,50,80
7126	Molded plug test lead [SA]	48,50,80
7127B	Simplified measurement probe	44,45,80
7128A	Test leads	50,81
7129A	Test lead with alligator clip	50,52,81
7131B	Safety crocodile clip [black]	57
7132A(KSLP5)	External earth probe	57,81
7133B(OMA DIEC)	Distribution board test leads	56,57,81
7139A	Test leads with remote control swtich	80
7141B	Voltage test lead set	62,64,81
7146	Banana $\phi$ 4 adjuster plug	15,71,72,81
7148	USB cable	62,66,81
7149A	Test leads with remote control switch set	35,81
7150A	Test leads with remote control switch set	32,57,81
7153B	Safety test leads	81
7154B	Safety test leads	81
7155B	Safety test leads with fuse	81
7156B	Safety test leads with fuse	81
7157B	Safety crocodile clips	74,81
7158B	Safety crocodile clips for fuse	81
7159B	Safety test leads with fuse	81
7161A	Flat test prod [black]	52,57
7165A	Line probe	37-40,82
7168A	Line probe with alligator clip	37-40,82
7170	Power cord	41,62,64,82
7185	Extension cable	66,70-72,82
7187A	Main test lead [UK]	49,54,55,82
7196B	Test leads with remote control switch	58,59,82
7217A	Test leads	34,80
7218A	Main test lead [EU]	49,54,55,82
7219	USB cable	64,68,69,82
7220A	Test leads	14,82
7221A	Main test lead [SA]	49,54,55,82
7222A	Main test lead [AU]	49,54,55,82
7224A	Earth cord	38,40,41,82
7225A	Guard cord	38,40,41,82
7226A	Line probe	41,82
7227A	Line probe with alligator clip	41,82
7228A	Earth resistance test leads	45,54,55,82
7229A	Earth resistance test leads	46,82
7234	Alligator clip	11,12,15,83
7238A	Simplified measurement test leads	46,83
7243A	L-shaped probe	33,35,58,59,83
7244A	Alligator clip	58,59,83
7245A	Precision measurement cord set	45,57-59,83
7246	Distribution board test lead	49,54,55,83
7247	Distribution board test lead	49,83
7248	Test leads	46,52,83
7253	Longer line probe with alligator clip	37-40,83
7254	Longer line probe with alligator clip	41,83
7256	Output cord	20,23,25,83
7260	Test lead with remote control switch set	33,35,83
7261A	Test lead with Alligator clip	33,35,83
7264	Earth cord	37,39,83
7265	Guard cord	37,39,83
7266	Earth resistance test leads	44,83
7267	Cable reel for Earth resistance tester (Red)	44,84
7268	Cable reel for Earth resistance tester (Yellow)	44,84
7269	Earth resistance test lead (Red)	84
7270	Earth resistance test lead (Yellow)	84
7271	Earth resistance test leads (Green)	44,84
7272	Precision measurement Cord set	44,55,84
7273	Voltage test lead	68,69,84
7275	Printer cable	52,84
7276	Adaptor for Extension cord	52,84
7277	Mains lead	52,84
7278	Earth cable	68,69,84
7281	Test leads with remote control switch	54,55,84
7284	Test lead with IEC connector	74, 84
7290	Voltage test lead set	61,84
<b>8000</b>		
8016	Hook type prod	32,33,35,57,58,59
8017	Extension prod	46,50,57,58,59
8017A	Extension prod long	33,35,55
8019	Hook type prod	37-40
8029	Extension prod	41
8031	Phase indicator	77
8031F	Phase indicator	77
8032	Auxiliary earth spikes [2spikes/1set]	45,46
8035	Non-contact Phase Indicator	77
8041	Auxiliary earth spikes [2spikes/1set]	44,54,55
8072	CAT II Standard prod	46,58,59
8112	AC Clamp Adaptor	29
8115	Clamp Sensor	11,15,29
8121	Load current Clamp Sensor	15,66,68,70,72
8122	Load current Clamp Sensor	15,66,68,70,72
8123	Load current Clamp Sensor	15,66,68,70,72
8124	Load current Clamp Sensor	62-66,68,70,71
8125	Load current Clamp Sensor	62-66,68,70,71
8126	Load current Clamp Sensor	62-66,68,70,71
8127	Load current Clamp Sensor	62-66,68,70,71
8128	Load current Clamp Sensor	62-66,68,70,71
8130	Flexible Clamp Sensor	62-66,68,70,71
8133	Flexible Clamp Sensor	62-65,68,70,71
8135	Flexible Clamp Sensor	62-66,70,71
8146	Leakage & Load current Clamp Sensor	15,64-66,68,70,72
8147	Leakage & Load current Clamp Sensor	15,64-66,68,70,72
8148	Leakage & Load current Clamp Sensor	15,64-66,68,70,72
8161	Clamp Sensor	11,29
8177	Ior Leakage current Clamp Sensor	68-70
8178	Ior Leakage current Clamp Sensor	68-70
8200-03	Cord reel [3pcs]	45,81
8200-04	Cord reel [4pcs]	46
8212-USB	USB adaptor with "KEW Report(Software)"	33,46,54,55,56,58,59
8212-USB-W	USB adaptor with "KEW Windows(Software)"	41
8216	Temperature probe	12,24,85
8241	USB Communication set	15
8253	CAT III Standard prod	46
8258	USB communication set	40
8259	Adapter for measurement terminal	44,45,55
8262	AC adapter	68,69
8263-USB	USB cable with "KEW Report(Software)"	52
8266	AC adapter	38
8267	AC adapter	38
8268	Ni-MH rechargeable battery	38
8302	Adaptor for recorder	39,40
8304	Resister for operation check	47
8309	Voltage sensor	66,70
8312	Power supply adaptor	62,63,65,70
8320	AC adaptor	25,66,70
8324	Adaptor for recorder	37,38
8326-02	SD card [2GB]	62,64,68,69
8327EU	Power adaptor 15V/1A	40
8329	Power supply adaptor	68-70

# PRODUCT INDEX

8343	Signal source for Intelligent Socket Tester	74	9192	Carrying case for cord reels	44,55
8405	Temperature probe	15,85	9193	Carrying case	52
8406	Temperature probe	15,85	9195	Carrying case	76
8407	Temperature probe	15,85	9198	Carrying case	61
8408	Temperature probe	15,85	9199	Shoulder pad	54,55
8901	Fuse [0.5A/250V]	12,85	<b>KAMP10</b>	Test lead with IEC connector	56,57,74,84
8918	Ceramic fuse [0.8A/600V]	12,85	<b>KT170</b>	Voltage Tester	79
8919	Ceramic fuse [10A/600V]	11,12,85	<b>KT171</b>	Voltage Tester	79
8923	Fuse [500mA/600V]	12,32,34,46,56,57,63,69,70,77,85	<b>KT200</b>	Digital Clamp Meter	78
8926	Fuse [440mA/1000V]	14,85	<b>KT203</b>	Digital Clamp Meter	78
8927	Fuse [10A/1000V]	14,85	<b>KTA01</b>	4mm metal tips [2pcs/set]	79
8928	Fuse [10A/250V]	52,85	<b>KTA02</b>	4mm rubber caps [2pcs/set]	79

## 9000

9029	Carrying case	77
9074	Cord case	32,34,35
9079	Carrying case	20,21
9084	Soft case	45,54,55
9089	Carrying case	32
9090	Carrying case	20,24,26
9092	Cord case	56,57
9094	Carrying case	20,23,24,27,70-72,77
9095	Carrying case	12,23,29,70-72
9096	Carrying case	25,74,77
9097	Carrying case	11,26,27
9103	Carrying case	12
9105	Carrying case	78
9107	Soft case	16
9113	Carrying case	27
9118	Carrying case [Soft]	66
9121	Shoulder strap	32-35,44-46,48,50,52,56,57
9123	Shoulder strap	35
9125	Carrying case	46,62-65,68,69
9130	Carrying case	13
9132	Carrying case with magnet	62,63,65,70
9135	Carrying case	63,65,66,70
9142	Carrying case	45,54,55
9147	Cord case	48,50
9151	Shoulder strap	54,55
9152	Carrying case	77
9154	Carrying case	15
9155	Shoulder strap	49,58
9156A	Soft case	49,58,59
9158	Carrying case [Hard]	38
9160	Carrying case	21
9161	Carrying case	46,74
9164	Carrying case [Hard]	45
9165	Carrying case [Hard]	45
9166	Carrying case [Hard]	47
9167	Carrying case [Hard]	47
9168	Carrying case	12
9171	Carrying case [Hard]	40
9173	Carrying case	33,35
9174	Carrying case	22
9176	Carrying case [Hard]	38
9180	Carrying case [Hard]	39
9181	Carrying case [Hard]	39
9182	Carrying case [Hard]	37
9183	Carrying case [Hard]	37
9186A	Carrying case	33,35
9187	Cord case	33,35
9188	Hard case	13
9189	Magnet hanger strap	11
9190	Carrying case	44
9191	Hard case	44



# QUALITY CONTROL CONCEPT

Kyoritsu started early an effort to establish system that ensures traceability to the national standards in order to produce reliable instruments as well as instruments that can assure reliability of other equipment and installations.

When traceability is in place, measurements taken with an instrument any time and anywhere in any situation can be related to the appropriate national measurement standards through a clear and unbroken chain of comparisons.

For example, in terms on measurement defined by JIS (Japanese Industrial Standards), traceability is specified as a condition in which a calibration path is established from instruments produced or in-house standards to higher level standards to the national standards. Kyoritsu currently has a system in place as shown in the figure below.

Our calibrator (standard) is calibrated at Japan Electric Meters Inspection Corporation (JEMIC), Japan Quality Assurance Organization (JQA) and Fluke Japan who perform calibration based on the units established and maintained by National Institute of Advanced Industrial Science and Technology (AIST). The standard is used as the in-house standard to calibrate all the test and measuring equipments which are used in-house.

**Voltage :** Precision calibrators are used as in-house DC and AC voltage standards.

**Current :** DC or AC current is converted to a voltage by a standard resistor, and the voltage is calibrated with a precision digital multimeter.

**Resistance :** Calibration resistors are calibrated with a DC standard current generator and the precision digital multimeter.

## Calibration System for Electrical Measuring Instruments

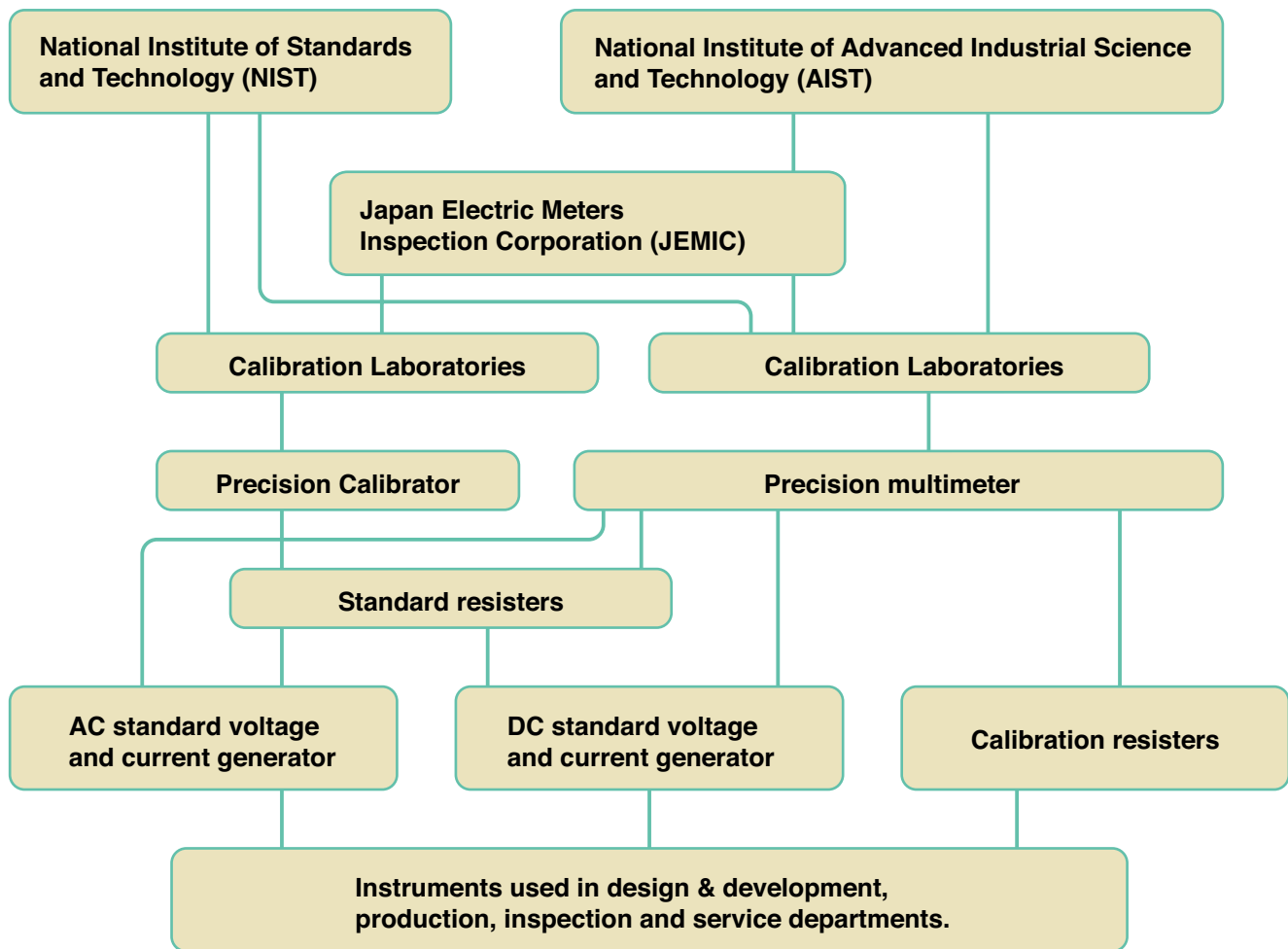

CE Marking: signifies conformance to  
EMC directive (2014/30/EU)  
LVD directive (2014/35/EU)  
RoHS directive (2011/65/EU)



## KYORITSU GLOBAL NETWORK

### ● KYORITSU ELECTRICAL INSTRUMENTS WORKS, LTD.

2-5-20, Nakane Meguro-ku, Tokyo,  
152-0031 Japan  
Phone: +81-3-3723-0131  
FAX: +81-3-3723-0152

### ● EHIME FACTORY

480 Sakado, Uwa-cho, Seiyō City, Ehime,  
797-0045 Japan

### ● KEW (THAILAND) LIMITED

Navanakorn Industrial Estate 60/48, Moo 19,  
Klongluang, Pathumthani, 12120 Thailand  
Phone: +66-2-529-0542  
FAX: +66-2-529-0541

### ● KYORITSU INSTRUMENTS ASIA PTE. LTD.

4008 Ang Mo Kio Ave 10, #02-20/21,  
Techplace-1, Singapore 569625  
Phone: +65-6336-3398  
FAX: +65-6366-1696

### ● KEW EUROPE OFFICE

Viale Rimembranze 93/18,  
20099 Sesto S. Giovanni (MI) Italy  
Phone: +39-34-74149005

### ● KEWTECH CORPORATION LIMITED

Suite 3 Halfpenny Court, Halfpenny Lane,  
Sunningdale, Berkshire, SL5 0EF, England  
Phone: +44-3456-461404

### ● KYORITSU SHANGHAI TRADING COMPANY LIMITED

Room 1303, No. 58 Yan'an East Road,  
Huangpu District, Shanghai 200002, China  
Phone: +86-21-6321-8899  
FAX: +86-21-5015-2015  
URL: <http://www.kew-ltd.com.cn>  
E-mail: [info@kew-ltd.com.cn](mailto:info@kew-ltd.com.cn)



  
**Official Website**  
[www.kew-ltd.co.jp](http://www.kew-ltd.co.jp)



Follow me!  
  
**Facebook**



 **YouTube**  



## Safety Warnings :

Please read the "Safety Warnings" in the instruction manual supplied with the instrument thoroughly and completely for correct use. Failure to follow the safety rules can cause fire, trouble, electrical shock, etc. Therefore, make sure to operate the instrument on a correct power supply and voltage rating marked on each instrument.

■ For inquires or orders :

**Blue Panther s.r.o.** Mezi Vodami 29, 143 00, Praha, Česká republika. Tel.: 241762724, Fax: 241773251  
e-mail: [info@blue-panther.cz](mailto:info@blue-panther.cz), [www.blue-panther.cz](http://www.blue-panther.cz)



In consideration of the environment, soy ink and recycled paper were used in this publication. ● The contents of this leaflet are subject to change without notice.

Gene Cata 23-24\_1E Feb.23 AD

Blue Panther s.r.o. Mezi Vodami 29, 143 00, Praha, Česká republika. Tel.: 241762724, Fax: 241773251  
[www.blue-panther.cz](http://www.blue-panther.cz), [www.blue-panther.sk](http://www.blue-panther.sk)